

CONTACT

THE PHOENIX PROJECT

"YE SHALL KNOW THE TRUTH AND THE TRUTH SHALL MAKE YOU MAD!"

VOLUME 6, NUMBER 5

NEWS REVIEW

\$ 2.00

July 26, 1994

Timely Warnings As The Current Events Get Nasty

Keep Goggles Handy — Search & Seizure Smarts

7/23/94 #1 HATONN

FINALLY GOT IT RIGHT!

The staff at *CONTACT* is glad that Hatonn finally did something right. We got a very nice letter a couple of days ago that suggested we needed more good things reported. No complaint about that which we write, but please offer more of what is going on that is good. With the letter came an example and a "Why don't you run this sort of thing...."

We had run the EXACT SAME MATERIAL so long ago that someone had to dig it out of the computer just to check on it.

We have ongoing connections with the people involved with the *COMMITTEE OF 50 STATES* and are pleased to see that this particular material is getting around so widely. The material in point is regarding an "Ultimatum" or there will be working afoot to "Dissolve the Union". It really goes right along with refounding and such, so don't despair—just pay attention and follow through. Be careful, however, for you are under surveil-

(Please see *TIMELY WARNINGS*, p.55)

FIRST CLASS MAIL

INSIDE THIS ISSUE

- About Those Black Helicopters, p.2
- Latest Intelligence From Militia Of Montana, p.3
- More From *THE USURPERS*: Schemers & Operators, p.6
- Nevada Corporations: *Advantages & Uses Of A Corporation*, p.18
- Urgent Plea From Alliance For America, p.19
- Pot-Stirring On O.J. Race Riots, p.19
- Truth Reveals Itself Even From Garbage, p.20
- CONTACT* Must Walk A Careful Line, p.22
- Jupiter & Bogus Boulders, p.22
- Buried In Questions Beyond Endurance, p.23
- Clintonistas' Dictatorship Strikes Again, p.24
- The *10th Amendment* Constitutional Revolt, p.32,44
- Grandma's Trump Card To Hopi Nation Plight, p.33
- Grandma Sings Golden Oldies, p.34
- Ronn Jackson Shares More Information, p.35,37
- "Insider Report" On Clintonista Shenanigans, p.37
- *** *THE Committee Of 17*, p.38 ***
- Shadow Government Organizational Chart, p.39
- Congressional Grace Caucus Awards, p.40
- Another Mind-Control Victim, p.45
- Grandma Torpedoes George Green, p.47
- Latest *JOURNAL* Dedicated To Native Americans, p.49
- Magnificent Dance Of Truly Conscious Life, p.51
- New Videotape: *This Is Treason*, p.60

About Those Black Helicopters...

Editor's note: As always, CONTACT would like to thank the SPOTLIGHT for their unrestricted sharing. To subscribe to SPOTLIGHT, call toll-free: (800)522-6292; price is \$38 for one year, \$70 for two years.

Exclusive to the SPOTLIGHT
by Mike Blair

A special detachment of high-tech surveillance helicopters, painted black and bearing no U.S. insignia, have been stationed at a National Guard base in Tupelo in northeastern Mississippi.

Fifteen of the Bell OH-58D(i) Kiowa Warrior helicopters, used with great effectiveness by the U.S. Army to pinpoint and/or attack Iraqi installations during Operation Desert Storm, were flown to Tupelo by members of C Company, 1st Battalion, 185th Aviation, based at Tupelo, in mid-April from the Bell Helicopters plant in Fort Worth, Texas.

According to SPOTLIGHT sources, the "super sleuth" helicopters comprise the Target Acquisition and Reconnaissance Company (TARC), which will apparently be permanently based at Tupelo.

"We're the only Guard unit to have them," Lt. Col. Dan Chisholm, 1st Battalion commander, said. "We may be the only [Guard] unit that will get them."

Big Brother could be watching you—from the sky. But why?



Bell OH-58D reconnaissance helicopter.

15 OF 50

Actually, the OH-58D(i)s are 15 of only 50 in existence and are equipped with the very latest reconnaissance and surveillance electronic gear.

According to a SPOTLIGHT source, the helicopters are equipped with Forward-Looking Infra-Red (FLIR) TV-digital tracker-laser range-finders and illuminators for surveillance and tracking of targets.

The source, a former U.S. Marine Corps forward artillery observer during the Vietnam War, told the SPOTLIGHT that the helicopters only operate at night, starting at about dusk.

They are responsible for some of the dozens of reports from various parts of the United States, as well as eastern Canada, of mysterious "black helicopters".

According to the SPOTLIGHT source, who himself has had the Tupelo installation under surveillance, said that each helicopter is manned by two crewmen, both dressed in black battle dress uniforms (BDUs), which do not appear to have any insignia.

When the source was watching the helicopters at the base, he and a companion found themselves being also watched, with the helicopters somewhat threateningly hovering about them, the front of the aircraft, displaying rocket pods, facing them.

The SPOTLIGHT source videotaped the helicopters.



Bell OH-58D reconnaissance and surveillance helicopters photoed at Tupelo, Mississippi.

ENTIRELY BLACK

Three of the helicopters, which are entirely painted flat black, were in the air at the time. After a few minutes of watching the two men on the ground, the crews of helicopters flew off, heading in a northerly direction.

According to E. A. Karpinski, a spokesman for Bell Helicopters, the Bell OH-58D(i)s' "primary mission" is to provide "night reconnaissance".

The Kiowa Warriors can carry up to four Stinger air-to-air missiles, up to four Hellfire anti-tank missiles, up to two 70-millimeter rocket launchers and/or .50 caliber machine guns with 500 rounds of ammunition.

The helicopters have a cruising speed of about 115 miles per hour and a top speed of more than 140 miles per hour.

In another incident in the southern United States, waves of dozens of dark-painted helicopters were reported to the SPOTLIGHT as

having created an uproar by flying over Kenner, Louisiana, near New Orleans, in the past several days.

When one observer lost count about 80 of the helicopters had already passed overhead.

A military analyst told the SPOTLIGHT that the helicopters could have been moving a full brigade of troops.

Dozens of Army Black Hawk helicopters, based at Fort Drum, New York, have been reported by Canadians to frequently fly across the border to unknown destinations in Canada.

Sources have told the SPOTLIGHT that Canadian troops are frequently seen at Fort Drum, located in upstate New York near the St. Lawrence River, which separates the United States from Canada. They train there with soldiers of the U.S. 10th Mountain (Light)

Division, which is permanently stationed there and has an urban warfare training center on part of the base.

Several bases in the eastern Canadian maritime provinces, as well as in the Province of Quebec, which is on the verge of seceding from the rest of Canada, have been turned over to the UN for training purposes and, reportedly, for stationing troops. Some Canadians speculate that this is to militarily prevent a Quebec secession effort.

They also note that Fort Drum is strategically located to send troops to intervene in Quebec.

SENT FOR TRAINING

Recently, a full brigade of the 10th Mountain was flown to Fort Polk, Louisiana, reputedly the

North American training center for the UN, for nearly two weeks of intensive "advanced readiness" training, which, according to reports, emphasized urban warfare training, including

BULLETIN

According to a SPOTLIGHT military source, who must remain anonymous, the U.S. Army trained a number of IRS agents in low intensity, urban warfare techniques—i.e., house-to-house fighting—at Fort Leonard Wood, Missouri, in the recent past.

North American training center for the UN, for nearly two weeks of intensive "advanced readiness" training, which, according to reports, emphasized urban warfare training, including

house-to-house searches for belligerents and weapons.

The exercise was a follow-up to the 10th being stationed in Somalia during the so-called mercy mission to feed hundreds of thousands of starving Somalis caught up in a civil war.

The mission was re-directed by the UN command to an effort to disarm militant factions under the command of feuding Somali warlords and included house-to-house raids to seize weapons.

Numerous critics of the so-called New World Order contend that Somalia was a training ground for U.S. troops to enforce draconian measures to be taken in America, including the confiscation of firearms, currently being pushed by leftists in Congress and the Clinton Administration.

In any case, while troopers of the Army's elite 10th Mountain Division were undergoing "advanced readiness" training, units of the U.S. Marines have been utilizing a mock village—used for training FBI agents—at Quantico, Va.

The Marines are receiving training in "Operations Other Than War" at the mock village, called "Hogan's Alley," at Quantico.

According to the June issue of *Navy Times*, the training at Hogan's Alley is being undertaken as part of the Marines' effort to train in urban patrolling, conducting convoy security, counter-ambush techniques, crowd/riot con-

trol, dealing with possible snipers, establishing strong points in urban environments, dealing from bomb threats and dealing with traumatized civilian populations.

Tactics being taught the Marines include how to properly employ sniper teams in low intensity/urban operations, establishing road-

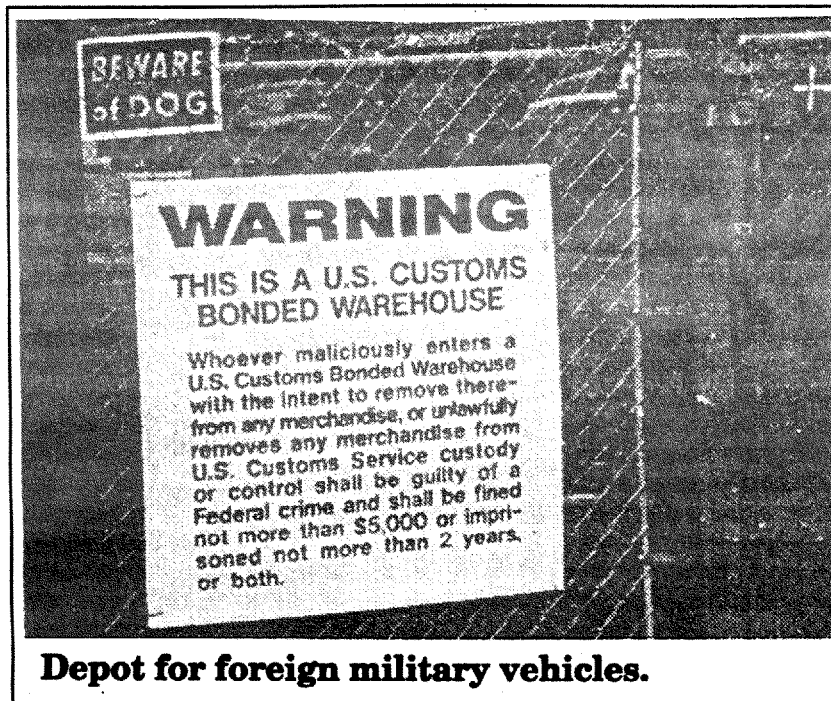

Depot for foreign military vehicles.

blocks and security check-points, and urban patrolling.

According to Marine Maj. Gen. Anthony C. Zinni, the number of war games, seminars and unit-level training for low intensity and urban operations is increasing, the *Navy Times* reported.

According to the *Times*:

"The new training syllabus differs greatly from the traditional military operations and urban terrain exercises—MOUT—where Marines invade cinder-block 'combat towns' firing mortars, rockets, machine guns and more, in an all-out urban assault. No, this training is designed for less intense military operations—as those in Somalia were originally intended to be—and is conducted in streets and neighborhoods of what many would consider *Anytown, USA* (*SPOTLIGHT* emphasis)."

SENT TO IRELAND

A team of U.S. Marines was recently sent to Britain to train with Royal Marines who have been involved in urban patrol experiences in Northern Ireland, long ravaged by civil war.

The *Times* further reported that after the Americans were sent to Britain, Hogan's Alley was selected for Marine training in urban warfare.

"Nestled in the woods adjacent to [the Marines'] Basic School, Hogan's Alley could pass for most small towns in America (*SPOTLIGHT* emphasis)," a Marine spokesman told the military publication. "There is a bank, a restaurant, a garage, you name it. There are streets and alleys, drugstores and townhouses. And today, thanks to more than 40 Marines who volunteered to play the parts, there are even local 'civilians' to bring the town alive. Put it all together and you have a typical urban environment where Marines may one day be called into action to conduct everything from security operations to peacekeeping initiatives."

Obviously, "Anywhere, USA," does not seem to depict the type of culture or village to be found in a Somalia or Haiti.

More Hot News From The Militia Of Montana

Editor's note: CONTACT would like to thank those at the Militia of Montana (MOM) for generously sharing their INTEL REPORT with us again [Intel information was first presented in our 6/28/94 issue starting on p. 58]. If you would like to receive MOM's newsletter TAKING AIM, send \$5 for a two-month trial subscription to P.O. Box 1486, Noxon, MT 59853 (406) 847-2246. [Or, \$15 for six months; \$25 for a one-year subscription.] It is our understanding that they will also be making audiotaped updates available on a weekly basis for a fee of \$5. And again, to the people at MOM, thank you for sharing.

INTEL REPORT
JULY 20, 1994

MILITIA OF MONTANA (MOM)
C/O P.O. BOX 1486, NOXON, MT. 59853

FOR WHAT IT'S WORTH

1. Reported evening of June 19, 1994. A secret program started before 1991 to send a rocket to Jupiter to arrive simultaneously when the fragments of the comet would strike. This rocket was carrying 49 1/2 lbs of plutonium and equipped with 750 kilo-ton nuclear war head (a comparison: Hiroshima was hit with a 50 kilo-ton bomb). This is an experiment by scientists who work for those who run the shadow government. This experiment was

done in order to see if they could ignite the planet in such a way that it would send out an electromagnetic pulse (EMP). This project is called "Apple Jack 95". This project is part of a program to depopulate the Earth (Global 2000 program commissioned by former President Jimmy Carter—2 billion to be left on the Earth). This EMP is to hit the Earth on July 26 in the Eastern Hemisphere. However, it is not clear at this time whether this date is meant for the Western Hemisphere or the Eastern Hemisphere. If it is meant for the Eastern, this would mean the Western Hemisphere could feel its effects on July 25. Also, it was stated that the strength of this EMP could cause the death of over 2 billion people. However, if it does not hit the Western Hemisphere directly the effects would not be as great. We were also told that the Western Hemisphere will feel nothing if it hits the Eastern Hemisphere. However, this is an experiment and nobody really knows what may happen. It could have no affect, or, 2 billion dead. Nobody knows.

MOM has been told that the way to detect if your area will be affected by the EMP is to have your radio tuned into an AM radio station. If the signal on your radio is suddenly lost and you hear static, you will have 38 minutes to prepare. So what can we do to protect ourselves? We were told that if you have a basement, root cellar or bomb shelter (something under ground) to go into it and

stay next to the eastern most side of your shelter. The EMP will last only approximately one minute. This report was told by a [deleted] who was [deleted] in the [deleted].

Also, we are still working on verification that Russia has been practicing war drills with the civilian population in their country. They are practicing going into bomb shelters, etc. Connection with the above?

MOM's Thoughts On The Above

MOM has received numerous reports comparable to the above in the past. So why are we putting this one on the network?

1. This report came from a [deleted] who [deleted] on the [deleted].

2. A patriot investigator who has been very reliable on Intel in the past has also been working on this and believes this report to be credible enough to be taken seriously.

3. We reported in the May issue of *Taking Aim* that there are four Russian typhoon class subs out of Mobile Bay. Each of these subs can carry 22 intercontinental missiles that have MIRV capability which means that each of these 22 missiles can carry 5-10 multiple war heads on them. After further investigation, when exploded at the proper distance these war heads can cause an EMP that will shut down all electronics that are not shielded properly. We are not sure what kind of damage

this can cause to life.

4. Also, we know that there is another electro-magnetic grid that has been established by the world-controllers for the purpose of weather and/or mind-control by sending EMPs over this grid wherever they wish (example: woodpecker signal near Eugene, Oregon during the early 1980s and investigated by Bob Beck in 1984—see Thomas Beardan's *Soviet Weather Wars Over America*).

Summary: We, at MOM, believe if this takes place it will be used as a cover for other purposes. What are we going to do? We are going to make sure we have a radio tuned to an AM station on the days of July 25 and 26 and if static comes across we will not put out a report on it until after we are sure that it is safe to come above ground once again.

One more thing. We have been told that by putting out reports of this nature we will lose our credibility and look like fruitcakes if the situation does not come to pass. We would like to know if you wish to receive these types of reports and not have the situation occur or would rather we not put out the report and have it occur. Please let us know. Thank you.

[Editor's note: Please refer to Commander Hatonn's comments beginning on p. 55 for more perspective on the above news.]

II. Reported July 19, 1994. Washington insider released information that there is a high probability that President Clinton will be gunned down by labor day. They will use an AK-47 with blame put on the Christian fundamentalists.

However, MOM is of the opinion that if this is going to take place that it will more than likely be during the march on D.C. beginning September 19. This will give the Fed the credibility that the patriot organizations throughout the country will need to be disbanded and disarmed. This could also cause the State of National Emergency that many are expecting to occur any way because of this march. Which would mean: suspension of the *Constitution*; patriot leader round-ups; and of course gun round-ups.

We, at MOM, realize all of the work Linda has been putting into this, however, we can not sanction her march (remember the bonus march of 1933 on D.C. when many patriots never made it home). Neither can we recognize her as the acting adjutant general of the unorganized militia of the United States of America (see Militia act of 1792.) No disrespect towards Linda intended.

Other Intel:

1. Reported June 20, 1994. Salt Lake City. Army reserve depot located next to the international airport has tanks dug in, in defensive positions with turrets pointed out over the runaways.

Fence around depot has signs that state that no pictures, sketches, etc., may be taken of this facility.

A 24-hour laser type security sensing system has been established around this depot.

Is it just a coincidence that the UNISYS Corp. is located nearby. Remember UNISYS was given the multi-billion dollar contract with the Federal Government for providing FEMA with the majority of the necessary computer programming which includes the relocation of the civilian population during times of crises (there was a partial congressional investigation into this matter which resulted in the disappearance of key witness Air Force

Lt. Colonel Consuegra): Confirmed.

2. Reported July 13, 1994. Noxon, MT. Men dressed in black BDUs were doing maneuvers near Noxon with boats and airplanes during the last week-and-a-half of June. These men practiced night maneuvers with boats, etc. These men also inspected the properties of certain people in this area.

After further investigation MOM has been told that the Office of Naval Intelligence was at work here. Source is unclear whether they were practicing or setting things up for future use. Also, have been told that this exercise was by Seal Team 6, dispatched by the O.N.I. It has been confirmed through numerous sources that this seal team is responsible for monitoring and stopping certain factions. Why were they in this area?

Conclusion: MOM—Activity confirmed. Still working on confirmation as to actual agency involved.

3. Reported July 17, 1994. Teenage couple went hiking in Glacier National Park, north of Kalispell, MT in the pole bridge area. Reported that these teenagers were accosted by foreign-speaking men dressed in black BDUs with black ski masks, had the [deleted] beat out of them; transported to the hospital by ambulance with broken bones. Parents of one of the couple were extremely upset and went into the area with the children and have not been seen since that time.

After further investigation, the hospital does not have any record of these teenagers being admitted nor does the local Sheriff's Dept. have anything on record.

A few weeks prior to this incident a woman who lives near the park was out with her children. They were on the east side of the park at a tourist attraction. This woman's daughter speaks French. There were a number of young men nearby (ranging between 18-26 years of age). The daughter started a conversation with them. They told her they were here working for the United States Federal Government and were being paid by the Fed. Connection? We do not have documentation or enough witnesses to proclaim this as confirmed; however, we have heard stories like this from around the nation and as far as MOM is concerned we believe this story to be factual.

We at MOM would like to thank all of our Intel gatherers for keeping us up to date on a regular basis so we can continue providing the rest of the nation, including congressional and state officers, of what is actually happening in America.

MOM's policy: We must act as a fire department acts, i.e., "When the bell rings, we have no choice but to go." In the majority of the incidents we do not have the luxury of time. So, we must ask your forgiveness, if there is a false alarm and we notify you all. However, we hope that you also realize the seriousness of the times that we live in.

We hate this part of it, but we must ask for donations to keep this Intel Network alive. Also, so not forget that MOM publishes a newsletter called *Taking Aim*. Subscription policy: \$5.00/2 issues; \$15.00/6 issues; \$25.00/12 issues. Again, thank you for all of the help!!!

"We are everywhere!" -- M.O.M.

(Editor's note: See M.O.M. update on next page that just arrived at our fax machine as we were going to press.)

NOW AVAILABLE

EXPANDED SECOND EDITION

654 pages

Defrauding America

by **RODNEY STICH**

• One of the most explosive books on the market for understanding the pattern of hard-core criminal activities implicating high federal officials and how it affects the American people. It describes and documents epidemic corruption by federal officials, and a pattern of criminal misuse of federal offices against the American public. The contents are supported by a group of former federal investigators, covert intelligence agency operatives and contract agents, former FBI, police, and private investigators, composing a block of whistleblowers.

Among the corrupt activities described in *Defrauding America* are the following:

- Epidemic drug trafficking into the United States.
- Role played by the CIA in Savings and Loan and HUD looting.
- Conversion of Chapter 11 courts into a criminal enterprise.
- October Surprise and its criminal coverup.
- The ugly part of the Iran-Contra scandal.
- Inslaw, the tip of Justice Department criminality.
- Covert CIA financial institutions dealing in drug money laundering.
- Crooked federal judges and Justice Department attorneys.
- Felony persecution of informants by Justice Department attorneys and federal judges.
- Killings and mysterious deaths of informants and whistleblowers.
- Schemes to assassinate or remove U.S. Presidents and presidential candidates.

BOOK REVIEW EXCERPTS ON DEFRAUDING AMERICA

- Dick Gregory, WOL Radio, Washington & Baltimore: **"Defrauding America should be on top of every Bible."**
- Fletcher Prouty, author of *Secret Team* and *JFK-The CIA, Vietnam and the Plot to Assassinate John F. Kennedy*: **"Your book is great."**
- Hollywood promotion celebrity, Irwin Zucker: **"A blockbuster."**
- Hollywood's John Austin's HIS features: **"The most explosive book on the market."**
- Israel Book Review: **"Considerable interest has been expressed in your new publication."**
- KTAR host Frank Baronowski: **"It's a book you can't put down."**

Companion book: *Unfriendly Skies*, a history of corruption and tragedies.

Order by mail or phone. Credit card phone orders to 1-800-247-7389. Mail orders to Diablo Western Press, P.O. Box 5, Alamo, CA 94507; or P.O. Box 10587, Reno, NV 89510. Either *Defrauding America* or *Unfriendly Skies* is \$25.00 plus \$2.50 shipping.

Hot Update From Militia Of Montana

APFN HQ 702-433-9916 -> LINK/CONTACT -> "APFN -> Friends Faxing Friends" 7/26/94 19:39:23 -> Sons/Daughters of Liberty ->

FROM : MOM

PHONE NO. : 4068472246

INTEL. REPORT
JULY 22, 1994

Jul. 25 1994 05:32AM P01

MILITIA OF MONTANA (MOM)
C/O P.O. BOX 1486, NOXON, MT. 59853
406-847-2246 v/fax

RE: INTEL. REPORT - JULY 20, 1994: "FOR WHAT IT'S WORTH"

IN THE LAST REPORT, WE DISCUSSED PROJECT APPLE JACK 95, CONCERNING AN EMP THAT MAY COME FROM JUPITER, WHICH MAY HIT EARTH ON JULY 25 OR 26.

AFTER THIS REPORT WAS PUT OUT WE HAVE RECEIVED WORD THAT SOME PEOPLE HAVE GONE TO THE POINT OF PANIC. LET ME STATE FOR THE RECORD, THIS IS AN EXPERIMENT AND NOBODY KNOWS WHAT MAY HAPPEN. AS STATED IN PREVIOUS REPORT, WE AT MOM ALSO STATED:

"WE, AT MOM, BELIEVE IF THIS TAKES PLACE IT WILL BE USED AS A COVER FOR OTHER PURPOSES."

WHAT PURPOSES? THERE ARE MANY THINGS THAT THE FED (UN) HAVE DEVELOPED THAT CAN CAUSE ALL OF OUR ELECTRONICS NATION-WIDE TO CEASE FUNCTIONING. ALSO, THE REPORTS OF BOB BECK AND THOMAS BEARDON PROVE THAT THE FED (UN) HAVE DEVELOPED MEANS TO COMPLETELY CONTROL YOUR MIND WHEN EVER AND WHEREVER THEY WISH TO DO SO (AGAIN I WILL SITE THE EUGENE, OR, INCIDENT IN THE EARLY 80'S). ALSO, A FORMER CONGRESSIONAL INVESTIGATOR HAS TOLD US THAT HE WAS PERSONALLY PROTESTING THE LAUNCHING OF THE SATELLITE THAT WAS CARRYING THE PLUTONIUM TO JUPITER (ALLEGEDLY).

AGAIN LET ME STATE THAT THIS WILL ONLY BE A COVER FOR OTHER THINGS THE FED (UN) WILL DO - IF IT HAPPENS. ALSO, WE AT MOM DO NOT BELIEVE THAT THESE SCIENTISTS CAN DIRECT AN EMP OF THIS MAGNITUDE TO HIT THE EARTH ON A CERTAIN DAY, TO HIT A CERTAIN SPOT ON THE EARTH FROM SUCH A DISTANCE AWAY. HOWEVER, LET ME SAY IT AGAIN - IF THESE EFFECTS OCCUR IT WILL NOT BE FROM JUPITER BUT FROM ANOTHER SOURCE (EARTH MADE EMP'S AND/OR ELF'S) CAUSED BY THE FED (UN) VIA EMP GENERATORS AND/OR NUCLEAR EXPLOSIONS AS A CATALYST SUCH AS THE ONES NOW ON THE SOVIET TYPHON CLASS SUBS NOW BASED OUTSIDE OF MOBILE BAY, AL.

NOW WHY WOULD THEY (UN) WANT THIS TO HAPPEN?
IN 1974 FORMER GOVERNOR OF CALIFORNIA RONALD REAGAN COMMISSIONED A STUDY ON HOW TO ELIMINATE CITY AND COUNTY GOVERNMENTS AND REPLACE THEM WITH REGIONALISM. THE FIRST REPORT WAS CALLED THE HAWKINS REPORT WHICH PROVED THAT WHAT REAGAN WANTED WOULD BE DETRIMENTAL TO THE STATE. HE WAS FIRED. REAGAN THEN COMMISSIONED ANOTHER REPORT - THIS ONE TITLED THE HOULIHAN REPORT. THIS REPORT OUTLINED HOW THEY COULD CREATE THE CLIMATE NEEDED TO MAKE THE TRANSITION FROM CITY AND COUNTY GOVERNMENTS TO REGIONALISM. THE REPORT STATES:

"THIS STUDY, FOLLOWING PREVIOUS C.I.R. ACTIVITIES, IS PART OF A STATEWIDE UNDERTAKING TO MODERNIZE AND IMPROVE CALIFORNIA LOCAL GOVERNMENT, INCREASE ITS RESPONSIVENESS, EFFICIENCY AND ECONOMY.

"THIS PARTICULAR REPORT, USING DOCUMENTED CASE MATERIAL, FOCUSES ON THE PROCESS---"HOW TO"---BY WHICH POLITICAL AND ADMINISTRATIVE LEADERSHIP IS EMPLOYED TO BRING ABOUT REALLOCATION AND REORGANIZATION.

-1-

APFN HQ 702-433-9916 -> LINK/CONTACT -> "APFN -> Friends Faxing Friends" 7/26/94 19:39:23 -> Sons/Daughters of Liberty ->

FROM : MOM

PHONE NO. : 4068472246 Jul. 25 1994 05:33AM P02

"UNDER THE CONTRACT, THE INVESTIGATORS WERE TO PROVE THE NECESSARY "REAL WORLD" INSIGHTS INTO WHAT HAPPENS TO BRING ABOUT CHANGE IN LOCAL GOVERNMENTAL STRUCTURES."

CHAPTER SEVEN

"1. THERE MUST BE A CLIMATE FOR CHANGE IN ORDER FOR THE RESTRUCTURING OF LOCAL GOVERNMENT TO OCCUR, WHETHER THIS RESTRUCTURING INVOLVES DRASTIC REFORM, REORGANIZATION, MODERNIZATION, OR A MINOR ADMINISTRATIVE REALIGNMENT. WHILE THE FOLLOWING DOES NOT REPRESENT AN EXCLUSIVE LIST, THE FACTORS MENTIONED HERE ARE THOSE WHICH MOST OFTEN CREATE SUCH A CLIMATE:

- A. A COLLAPSE OF GOVERNMENT'S ABILITY TO PROVIDE NEEDED SERVICES;
- B. A CRISES OF MAJOR MAGNITUDE;
- C. A CATSTROPHE THAT HAS A PHYSICAL EFFECT ON THE COMMUNITY;
- D. THE CORRUPTION OF LOCAL OFFICIALS AND
- E. THE HIGH COST OF GOVERNMENT AND THE DESIRE FOR A HIGHER LEVEL OF SERVICES.

2. SOME CHANGE WILL OCCUR, IN ONE FORM OR ANOTHER, IF ANY OF THE FIRST FOUR FACTORS (COLLAPSE, CRISIS, CATASTROPHE OR CORRUPTION) ARE PRESENT, ESPECIALLY WHEN THEY ARE OF MAJOR DIMENSION."

THIS IS JUST A SAMPLING OF THIS 195 PAGE REPORT PUT OUT BY JOHN C. HOULIHAN, EXECUTIVE DIRECTOR, FOR GOVERNOR RONALD REAGAN. NOW WE CAN SEE WHY THE FLOODS IN THE MISSISSIPPI VALLEY, THE EARTHQUAKES IN CALIFORNIA, THE FLOODS IN GEORGIA AND FLORIDA AND ON AND ON AND ON.
BELIEVE ME THESE ARE MAN MADE. DO THE RESEARCH, YOU WILL FIND OUT FOR YOURSELVES.

WE WOULD ALSO LIKE TO REITERATE THAT WE ARE HERE TO BRING YOU THE REPORTS AS WE GET THEM. IF OUR CREDIBILITY IS LOST BECAUSE OF OUTLANDISH REPORTS AND/OR FALSE ALARMS - THEN SO BE IT. ALL MILITIA MEN MUST RESPOND LIKE THE FIRE DEPARTMENT. "WHEN THE BELL RINGS. WE MUST RESPOND - FALSE ALARM OR NO. THIS IS OUR DUTY.

THEY (UN) NEED CATASTROPHES IN ORDER TO BRING THE AMERICAN PEOPLE TO THEIR KNEES BEGGING FOR HELP FROM THE ELITISTS. THEIR (MAJORITY OF AMERICANS) WILL GIVE UP ANYTHING TO FEED THEIR CHILDRENS STOMACHS. THEY (UN) KNOW THIS.
DO NOT GIVE IN. WE SHALL PREVAIL.

ONCE AGAIN, MOM WILL HAVE IT'S RADIO TUNED TO AN AM STATION ON JULY 25 AND 26 FOR WE FULLY UNDERSTAND THAT IT IS BETTER TO BE PREPARED THAN NOT BE PREPARED.

IF YOU HAVE ANY QUESTIONS, PLEASE FEEL FREE TO WRITE OR CALL. THANK YOU.

END INTEL.

THANK YOU,
RT.

We are every where

-2-

Schemers: Rostow, Fortas, Clifford; Operators: Katzenbach, McNamara

More From: *THE USURPERS* Schemers & Operators

Editor's note: Part 1 of this ongoing series began on p. 35 of the 6/28/94 CONTACT; Parts 2 & 3 began on p.3 of the 7/5/94 issue and Parts 4-6 began on p. 24 of the 7/12/94 issue and Parts 7 & 8 start on p. 2 of the 7/19/94 issue. Here we continue with antics about the Schemers: Rostow, Fortas, Clifford and Rusk; the Operators: Katzenbach and McNamara. This is a pivotal segment of our nation's modern history and downturn to socialism.

7/19/94 #1 HATONN

To save precious time and still be able to cover lots of information I ask that Dharma take up with *THE USURPERS* and let us write on that subject a bit each day—these are representative of very important players in the game afoot even if their tenure was "past" in apparent power. These are the tools of the RULERS who often grow to become the RULERS in FACT.

Our last writing on this subject was regarding McNamara and there shall we take up again:

THE USURPERS, Part 9
by Medford Evans

Western Islands (publishers), Belmont, Massachusetts 02178, 1968.

[QUOTING:]

**THE OPERATORS
THE TFX SCANDAL**

(TFX: Tactical Fighter, Experimental)

There is one important event in the disarmament activities of the former Secretary of Defense which can just as well stand for everything else, since in it are manifest all the personal characteristics of the man, especially his implacable refusal to countenance the least consideration for American victory on the field of battle.

The event to which I refer is known as the "TFX Scandal", which had been the subject of intensive Congressional investigation, was cut off just as it was reaching a first crisis by the assassination of John F. Kennedy.

"The multibillion-dollar TFX warplane contract was the most coveted prize the Pentagon ever dangled before bidders," writes Liberal journalist Clark Mollenhoff in his book *The Pentagon*:

Government spending, it was estimated, would exceed \$6.5 billion [it was to run much higher] the largest contract for military planes in the nation's history. The program was planned to include more than 1,700 planes for the Navy and the Air Force.

Such a contract could mean prosperity for an entire state, and the competition was intense.

Nineteen-sixty-two was the year of decision. There were two main competitors—Seattle-based Boeing, which proposed to build the plane at its Wichita, Kansas plant, and General Dynamics, which in cooperation with Grumman intended to produce the Air Force version at its Convair plant in Fort Worth, and the Navy version at Bethpage, New York. The states of Washington, Kansas, Texas, and New York were politically interested. The first two are hardly a match in political influence for the last two, even waiving the fact that the Vice President was from Texas. But that was something no one was quite willing to waive, particularly in view of Johnson's well-earned reputation for arm-twisting in the clinches. Senator Henry "Scoop" Jackson of Washington, in years gone by one of David Lilienthal's backers on the Congressional Atomic Committee, and more recently active with McNamara in the slandering of General Walker, now, awakening to alarm, raised a quite legitimate question with the Pentagon. Could it be that through Johnson and such, the state of Texas had the TFX contract sewed up and Boeing might as well forget it? He was assured that there was no bias anywhere, the contract would be awarded fairly.

On November 24, 1962 General Dynamics got the TFX contract. One wonders how this could have been, considering:

1) All four services—Army, Navy, Air Force, Marine Corps—expressed a preference for the Boeing plane, technically.

2) The Boeing plane was \$100 million cheaper than General Dynamics in the experimental phase, and was estimated at more than \$400 million cheaper on the total contract.

3) The Pentagon Source Selection Board, a top-level group of generals and admirals, were unanimous in preferring Boeing, both for performance and economy.

In spite of the foregoing facts, Defense Secretary McNamara, supported by Deputy Defense Secretary Roswell Gilpatric, Air Force Secretary Eugene Zuckert, and Navy Secretary Fred Korth ruled that General Dynamics

should get the contract. Challenged as to why, McNamara replied, essentially "Because" The arrogance of this decision was incredible. Indeed, the sheer preposterousness of the thing through shock value, seemed to be a kind of protection. Nobody could quite believe that an allegedly logical man like McNamara would not only make, but doggedly stick to, a decision of such importance without one shred of logic what-soever to support him. That's what he did. Mollenhoff, in his 1965 book *De-spoilers of Democracy*, tells of his own interview of McNamara, who received him in friendly fashion, leading off with flattering references to Mollenhoff's intellectual capacity. Mollenhoff does have intellectual capacity. He knows when he is getting

the run-around. He poured pressure on the Secretary of Defense:

"How will you justify discarding the low bid on the basis of a rough judgment and without cost studies?" I asked.

"I'm a \$500,000 a year executive," McNamara snapped back. "I was the second-highest-paid accountant in the United States. I was paid for my judgment on contracts involving millions of dollars."

"But Mr. Secretary," I said, "assuming that you can make these judgments on multibillion-dollar contracts, do you feel it is good government operations when there are no documented cost studies to justify throwing out the low bids?"

"I know what I'm doing," he snapped, a little angry now. "I was the second-highest-paid accountant in the United States." (pp. 190-191.)

That interview was a good day in the education of Clark Mollenhoff, and he has since done good work in contributing to the education of American voters and taxpayers. [H: Yes perhaps—but look who seems to keep on paying and paying.]

Somebody has done some reading—and thinking. World Bank promotion or no World Bank promotion, Robert McNamara cannot in 1968 say as he did in effect in 1962: "I am Sir

*The Men Who Rule
America.*
Special attention to:
**Walt Rostow,
Dean Rusk,
Robert McNamara,
Clark Clifford,
Abe Fortas,
N. deB. Katzenbach**

Oracle, and when I open my lips let no dog bark!"

The year 1963 was a turning point in many lives, though in the case of Robert Strange McNamara the effect was not yet to be conspicuous. Close-up observers in Washington, such as reporter Clark Mollenhoff, and a few Congressmen, began to learn with the McClellan Committee Hearings, initiated in February 1963, such indigestible facts as these:

(1) By all the ordinary rules of contractor-selection Boeing won the competition with General Dynamics hands down; the Boeing plane was better, it was cheaper, it was more suitable to defense needs.

(2) Secretary McNamara hardly bothered even to allege reasons for his arbitrary selection of General Dynamics, except (a) to cite his own reputation, and (b) to predict long-term savings resulting from "commonality" of parts between the Air Force and Navy versions of the plane—a contention in part purely speculative and in part dependent on a degree of similarity between the two versions which resulted, chiefly because of excess weight, in an inferior Navy plane. The Secretary also implied (c) that General Dynamics' higher bid was more realistic than Boeing's lower one! Thus, what might have been thought a Boeing advantage was turned into a liability. The reason McNamara knew General Dynamics' higher bid was actually more economical than Boeing's lower bid was that he could "just tell".

(3) General Dynamics desperately needed a financial windfall; since 1957, when under the late John Jay Hopkins the firm had earned \$56 million on sales of \$1.7 billion; it had, under placid former Army Secretary Frank Pace, sustained the biggest loss on one project in American corporate history—a loss of \$425 million, more than twice as much as Ford Motor Company lost on McNamara's Edsel.

(4) Involved in awarding the life-saving multibillion-dollar contract was McNamara's Deputy, Roswell L. Gilpatric, a New York lawyer friend of Frank Pace. Gilpatric had represented General Dynamics. His firm, Cravath, Swaine & Moore, still did. He had quit the firm he said, but the record showed that he was still carried by the firm's group insurance. When, eventually (1964), Gilpatric resigned from the Defense Department he went right back to the law firm.

(5) Also involved in awarding the contract was Fred Korth, a Fort Worth banker whom John Kennedy had named as Secretary of the Navy when John Connally resigned to run for Governor of Texas. Odd facts about Korth: He was, in 1952-1953, Assistant Secretary of the Army under the ubiquitous Frank Pace. Though Korth was Kennedy's Secretary of the Navy for nearly two years, his name does not appear in the indexes of Arthur Schlesinger's, Ted Sorensen's, or Pierre Salinger's books on Kennedy. Korth, who plainly knew nothing about naval aviation, overruled his top admirals' analytically documented preference for the Boeing plane, so that he could sign, along

with Air Force Secretary Zuckert and Robert McNamara, the award of the contract to General Dynamics. Korth's bank had made a loan of \$400,000 to General Dynamics, which loan was outstanding while Korth was deliberating the TFX contract. **[H: Doesn't all this smack of things TODAY?]**

The foregoing is the merest suggestion of what came out during Senator McClellan's 1963 investigation of the TFX contract. It became crystal clear that Robert McNamara, supported by Gilpatric, Zuckert, and Korth, had arbitrarily, in defiance of every rational indication of the merits in the case, awarded the biggest contract in history to a firm threat-

ened with bankruptcy, having business and financial ties to Gilpatric and Korth, and—of course—having its Convair plant in Fort Worth in the home state of the then Vice President of the United States.

President Kennedy had said that he saw nothing improper in the handling of the TFX contract award—but at the same time he made it plain enough that the White House had not been directly involved,

that the whole deal was handled by the Department of Defense.

Hindsight is easier to acquire than presight. In the case of the TFX contract the hindsight available in 1968 confirms the foresight which began to dawn on Clark Mollenhoff, Senator McClellan, and a few others in 1963. *For we know now that McNamara's decision was not only arbitrary and unreasonable. It was wrong.*

From an abundance of documentation available, I take from *Science News* of October 21, 1967 an article entitled, "The Flying Edsel". **[H: How many of you remembered the fiasco of Ford Motor Company's "Edsel" automobile? Did you remember that it was McNamara's fiasco? No? Well then, don't continue to ask me why WE ARE WRITING ALL THIS OLD INFORMATION—IT IS BECAUSE YOU ONES DO NOT REMEMBER AND, THROUGH FORGETTING—YOU LOSE THE PLAYERS!]** Writes science reporter Jonathan Eberhart:

Five years ago, Defense Secretary Robert S. McNamara overruled his source selection board and picked General Dynamics over Boeing to build the TFX, a jet superfighter now famous—or notorious—as the F-111. The plane's big advantage was supposed to be that both the Air Force and the Navy could use it. This, said the Secretary, would save at least \$1 billion. It hasn't worked out that way.

Eberhart reports how Grumman Aircraft, responsible as a General Dynamics co-contractor and subcontractor, objected to the very concept of "commonality" of parts between the Air Force and Navy versions—though "commonality" was the only understandable piece of rationalization which McNamara had offered in support of his otherwise patently bad judgment. The problem was that the Navy needed a lighter plane than the Air Force did—

to operate from carriers. But if in the interests of "commonality" the Navy was stuck with various features which the Air Force wanted, then there was no way to get the weight down to a usable level for the Navy. Eberhart quotes Grumman as writing:

The weight savings achievable... are directly proportional to the permissible reduction in airframe commonality, [which Eberhart translates]: "This airplane is too heavy and it's going to stay that way as long as the Navy has to worry about the Air Force's design limitations."

Actually, the TFX (Tactical Fighter, Experimental) turned into three planes for production: the F-111A, for the Air Force, the F-111B, for the Navy; and the FB-111, a strategic bomber, to replace the B-52, for heaven's sake! Don't ask why a plane which is already a mess because of attempts to make it serve incompatible purposes as (a) a land, and (b) a sea fighter, is now selected to fulfill also the radically different purpose of strategic bombing.

Meanwhile, all three versions are a continual headache to the military. The Air Force version is apparently least objectionable, but it too has "troubles of its own", according to Eberhart. Its loaded takeoff weight is six tons, or 17 per cent, more than what the contractor had guaranteed. There is a "speed brake" which "vibrates enough to cause buffeting of the aircraft," "improper location of... the center of gravity" has made landing hazardous, and finally—and inevitably—"production schedules have gone completely to pot." The Navy version is at present three years behind schedule—while the Navy's presence in Vietnamese waters is well ahead of schedule. Costs are astronomical. Both Air Force and Navy style F-111's were originally to have come to \$2.9 million apiece (an increase of 21 per cent), the Navy version at a cool \$8 million each, or an increase in unit cost of 175 per cent! **[H: Still can't top that of the little stealth fighter at well over half a BILLION last year.]**

There is a law of diminishing returns in pursuing too far a financial and managerial fiasco like the McNamara-TFX-General Dynamics thing, but one more point must be made: Boeing wanted to equip the TFX with a "thrust reverser", for reducing speed for landings. But Robert McNamara said no—too advanced, too risky. We must have a solid, safe, approved conventional dive brake such as General Dynamics had come up with.

Now hear this, from *Science News* writer Eberhart concerning the Navy's aerial monstrosity:

The aircraft's speed brake, a panel that lowers into the air stream from the fuselage, needs strengthening and redesign because it vibrates like a loose shutter, and a device called the adverse yaw compensator does such a poor job of controlling the plane's side-to-side motion that it adds to the already considerable hazards of night landings on an aircraft carrier, from which the F-111B's will operate.

It isn't just a matter of dollars and cents, though dollars and cents are important. We must think of McNamara sitting there insist-

ing that young Navy fliers have got to trust their lives, and the life of every sailor on the carrier, to the unmanageable bulk of one of these General Dynamics creations.

General Dynamics could have been helped financially far more simply, and without great commotion, simply by (1) continuing to produce B-58 "Hustler" bombers at the Convair plant in Fort Worth, (2) continuing to produce Atlas missiles at the Convair plant in San Diego, (3) going ahead with nuclear-powered naval vessels, a program in which General Dynamics, builder of the *Nautilus*, the first nuclear-powered submarine, could logically have been included. Instead, *the B-58 and the Atlas were discontinued*, and McNamara made another of his arbitrary decisions to build a *non-nuclear* aircraft carrier rather than a nuclear-powered one—once more against all the best naval, military, and other technical advice. [H: Does anybody, except me, see TREASON here?]

Mollenhoff writes, "With all of the opinions and facts against him, Robert S. McNamara made the decision that the United States should not go ahead with a nuclear carrier." McNamara's "Flying Edsel" may have been ordered to please General Dynamics; his "Floating Edsel" could have pleased no one but the Disarmament Lobby.

The chilling significance of Robert McNamara is this: that a dedicated opponent of American national defense could for seven years be American Secretary of Defense.

Admiral Canaris was Hitler's chief of military intelligence for nine years, and he was also head of an underground plot against Hitler. [H: How many of you remember the name and person of "Canaris"? Well, now, how many of you remember the connection with Gunther Russbacher? So be it! Perhaps you simply can't hear these same things repeated often enough?] Most of us are not inclined to think that was morally so bad of Admiral Canaris. There are plenty of people who think it would be fine if a U.S. Secretary of Defense, sworn to defend our country, should actually think it his duty to help run the whole World in the interests of "peace," and to that end to use his position as a means of destroying armed might.

There are American intellectuals who consider that America is the threat to what they value in the world, and that they are doing their duty if they deliberately weaken America. Is this why McNamara sought more and more power? Should he be in a position of power—in the U.S. Government, the World Bank, or anywhere else?

What McNamara did for seven years—three under Kennedy, four under Johnson—was to use the pretext of economy for disarming America.

Newsweek said December 11, 1967: "Few men have worshiped planning as obsessively as the eighth Secretary of Defense—and few have been *relieved of command* [Italics added] in such a shambles of confusion." In such shambles of confusion totter and topple the towers of tyranny!

But to think that McNamara has now been "put out to pasture" is to fail to understand the nature of the fields into which he now has been turned. The World Bank is the pilot institution of the Government. Set up at Bretton Woods in July 1944, the World Bank, or "International Bank for Reconstruction and Development", along with the companion institution the "International Monetary Fund",

was the first of the UN organizations to be established. The Bretton Woods conference was held two months before the Dumbarton Oaks conference at which was planned the more pretentious but hardly more influential organization that we call the United Nations. The UN had been set in motion under the guidance of Communist Alger Hiss at San Francisco in April of 1945. Hiss was an official U.S. delegate and secretary general of the conference! The UN was to maintain "peace"—which hardly anybody thinks can really be done. The World Bank was to manage the flow of money in the world—which lots of people think is being done very effectively, though not in the interest of the United States.

Regarding our current predicament, my conviction is that the whole buildup in Vietnam has as its purpose the distribution of wealth throughout the world in such a way as to make that wealth, whether greater or not, more manageable. And whether we have war, peace or negotiations, the *buildup* goes on.

Viewed functionally and from the offices of the threatened World Government, the Pentagon is subordinate to the World Bank. Our vast military operations are a means of the *buildup*, exist in order to make the *buildup* possible. But such a means, however vast, is not to be compared in ultimate importance with the management of that buildup once it is attained.

In the Pentagon, Robert Strange McNamara did the sinister work of so directing the American military effort that a maximum of material buildup occurred in Vietnam, while a minimum of fighting which might really injure Communists or help the American national image was allowed to take place. Perhaps his job is virtually complete. The United States has unloaded in Vietnam enough military personnel and materiel to conquer a continent, without accomplishing any military purpose whatsoever. What could have more highly recommended Robert McNamara to the ministers of the dreamed-of World Government!

To aspire to a job formerly held by Eugene Meyer, John J. McCloy, Eugene Black, and even George D. Woods is no mean ambition. *Newsweek* is quite correct, concerning McNamara, in concluding:

As head of the World Bank, he will technically be an international official, and likely will remain publicly aloof from the war and the Presidential campaign. But there is no reason to doubt that Bob McNamara will some day find himself back in the thick of American public life—perhaps with even more power than he wielded so well at the Pentagon.

There may be reason to think that the head of the World Bank is more powerful than a mere defense secretary of a nation—even "the most powerful nation in the world".

Left-leaning writer Emmett John Hughes shows signs of distress when he writes: "And as the din burbles ever higher, a brilliant and weary Robert McNamara prepares to depart from the Pentagon." "[yet] he cannot feel sheer anguish as he turns from Defense Department to World Bank." In fact, concludes Hughes with the wisdom of the heart, "It will be good for him to be back from the dark land beyond the looking glass," and adds semicryptically: "It will be even better when

the nation can follow."

Does this mean when the nation can follow its erstwhile Secretary of Defense into becoming frankly and fully international?

McNamara's usurpations in the office of Secretary of Defense are impressive. His opportunity for grander usurpations from this point on will be even more so.

[END OF QUOTING]

When we again write on *THE USURPERS* we will take up a person whose name is not so well recognized—perhaps as in "Brzezinski" the effort to learn pronunciation and spelling is too much for most people to handle. So, Katzenbach becomes the dubbed version and the heinous actions are lost in the effort to pronounce or spell the name of the traitor later. Remember that as in the case of Henry Kissinger and Brzezinski—the names were not originally THESE. The facts are that you the people do not know to whom you owe your debt of gratitude for the loss of your nation, freedom—and ultimately—planet. You don't even know who is Shirley Maclaine (really), so how are you ever going to reclaim your property? From whom? Mostly you will find that, at the original source, as with the Bolsheviks and beginners of the Communists in Russia—they were all Jewish in origin and simply changed their names to fool as many as they could—IT WORKED!! NEVER FORGET—IT WORKED!! AND, IT IS WORKING AGAIN!!!

7/19/94 #2 HATONN

THE USURPERS, Part 10.
by Medford Evans

[QUOTING:]

THE OPERATORS

NICHOLAS deBelleville
KATZENBACH

Personalities serving to link the Old and New Left are not easy to find. If they were, it would—in espionage terms—"blow the cover" off the New Left, would reveal it as a stratagem of the Establishment. Yet there are such personalities, and I think I know who a few of them are. Perhaps the most strategically placed is Nicholas deBelleville Katzenbach, the Un-

MORE READING

• To order Eustace Mullins' excellent book, RAPE OF JUSTICE, please write to:
Ezra Pound Institute Of Civilization
P.O. Box 1105
Staunton, VA 24402.
(\$18.00 + \$1.80 for bookrate shipping)

• "Dr. John Coleman's" fine book, CONSPIRATORS' HIERARCHY: THE STORY OF THE COMMITTEE OF 300, is available from:
Joseph Publishing, % W.I.R.
2533 N. Carson St.
Carson City, NV 89706.
Also available is his new book, DIPLOMACY BY DECEPTION: \$20.00 each book, including shipping & handling. For orders by credit card, please call 1-800-942-0821.

der Secretary of State.

Katzenbach's office is of vastly more importance than the public is likely to realize. Dean Acheson was Secretary of State when he announced that he "would not turn [his] back on Alger Hiss," but he was Under Secretary of State with Communist Hiss. It was also during his term as Under Secretary that Acheson promoted the "Acheson-Lilienthal Report" on atomic energy which laid the foundation for the later psychological nuclear disarmament of the United States.

Dean Rusk and Nicholas deB. Katzenbach think alike on Vietnam; if they seem not to, then one of them is fooling the public; they cannot fool each other.

My own opinion is that it is Rusk who is at least trying to fool the public. His tough talk about Hanoi and Peking does not disturb Peking or Hanoi, for they know that Dean Rusk is, like themselves, incapable of a deep break with Moscow. McNamara used to indulge in tough talk, too, or had such talk attributed to him.

Now that he is out, his "dovishness" is admitted. The essential point is that neither Rusk nor McNamara, and certainly not Katzenbach, ever intended to win anything for America in Vietnam. Lyndon Johnson doesn't either. The President's approval of his Secretary of State Dean Rusk is as implicit in the total situation as is Rusk's approval of Katzenbach. Also unanimous with them are those whispered-

If we Americans were over there really fighting Communism, as Dean Rusk says we are, (while Katzenbach, disappointingly enough, says nothing) then that in the eyes of the New Left would be a frightful thing. But if as a result of our being there the Viet Cong are going to inherit the great civil engineering works on which we seem to be doing so much better, and more successfully than we are in fighting, why then things are not so bad after all, and all the men and women of good will who so thoroughly despise the U.S. Establishment should "be heartened", as Lydia Katzenbach says.

about powers behind Johnson's throne—Justice Abe Fortas and the new Secretary of Defense Clark Clifford. In his newly acquired cabinet post, Clifford is not altogether behind the throne, but his total influence is undoubtedly greater than any cabinet post alone could make it.

What distinguishes Katzenbach from the others in this group, which could be enlarged to include Rostow and McGeorge Bundy, is his relative youth, forty-six, and his comparatively open identification with more respectable edges of the New Left. Writing in *The New York Times Magazine*, author Victor S. Navasky says Katzenbach's image has been that of a "courageous egghead, a civil-rights activist, an intellectual..." He was a "new Frontiersman and R.F.K. protégé". Today, many who once saw that image see instead, says Navasky, a "mindless defender or passive acceptor of a tarnished Vietnam policy". Navasky admits that either image may bear "little relation to his real role".

What is Katzenbach's real role? He had appeared to be a link between Bobby Kennedy and Lyndon Johnson.

He has been helped in this role by the transfers of jobs he has had during the Johnson Administration. At the outset, following the assassination, when he performed very crucial services, he was Deputy Attorney General, a position of great importance at the time because of the incapacitating crisis in the personal life of the Attorney General, Bobby Kennedy, whose brother had been the victim.

Today, as we have seen, he is Undersecretary of State in spite of the fact that at the Justice Department he had been elevated to the top post.

The job of Deputy Attorney General, however important it may have been in such circumstances, is a logical stepping stone to only one other job, which is that of Attorney General. When Bobby left that job to run for the Senate in the Fall of 1964, Katzenbach was made Acting Attorney General, at Bobby's request. Four months later, in January 1965, Johnson nominated Katzenbach for Attorney General, and the Senate confirmed him. The important thing is the coincidence of Johnson's and Kennedy's shared confidence in this veteran of the government's campaigns against Mississippi and Alabama.

Nicholas deBelleville Katzenbach, born in 1922, grew up with all the advantages of a well-to-do and reasonably prominent New Jersey family. Phillips Exeter, Princeton—interrupted by a wartime commission in the Air Force, which in turn landed him in POW camps in Italy and Germany—then Yale Law School, then, as a Rhodes Scholar, Oxford. [H: They just covered a lot of questions in that past paragraph, didn't they?] He taught law at Yale and at the University of Chicago. He became a full professor at Chicago at age thirty-four, and with a Ford Foundation grant in 1960 worked at Geneva on a project in international law. Katzen-

bach was ready to help the Justice Department, the country, and Mankind by accepting in 1961, as a New Frontiersman, the post of Assistant Attorney General in charge of the Office of Legal Counsel, from which he moved rather quickly to Deputy Attorney General.

It was as Deputy Attorney General that Katzenbach went to Oxford, Mississippi in September 1962 to command the civilian government forces which overcame the more rambunctious Ole Miss students, assorted rednecks, and a handful of agents provocateurs. It was as Deputy Attorney General that the next summer he confronted George Wallace at Tuscaloosa and participated in the charade which integrated the University of Alabama. Ironically, while Katzenbach and the Mississippians alike suffered losses in the melee

over James Meredith at Oxford, both Katzenbach and Wallace emerged with shining armor from the entirely bloodless encounter at Tuscaloosa. Image-wise, Wallace was the greater winner, since no party or faction anywhere has yet promoted Katzenbach as Presidential timber.

Katzenbach has, however, moved the levers of power. Navasky quotes "a prominent Washington attorney" as saying: "Nicholas Katzenbach has one genius, and only one genius. He knows how to handle Lyndon Johnson."

Katzenbach's wife Lydia seems to encourage the possibility. "If Nick were allowed to talk about what he is doing, a lot of our friends would be heartened." When Victor Navasky quotes Katzenbach's wife as making that statement, he indicates in the context that the "friends" in question are "members of the intellectual community", particularly various literary summer residents of Martha's Vineyard who had been upset by what they evidently regarded as Katzenbach's going over to the Establishment. Don't worry, Lydia seems to be saying, good old Nick is either going to sabotage those frightful hawkish plans of LBJ and Rusk—or else he knows that the plans don't really mean what the headlines say anyhow, and in the long run the Viet Cong will be better off for what we are now doing in Vietnam. So don't worry!

Maybe the Katzenbachs know how much truth there is in what an American construction foreman allegedly said at Bien Hoa in Vietnam not many months ago. One cannot imagine that Lydia Katzenbach would not read the December 1967 *Ramparts*, in which there is an article on Johnson's construction company, Brown and Root, who do lots of construction these days in Vietnam. The construction foreman, just drunk enough to be telling the truth, is reported to have said:

We're just building all this for the VC anyway. They'll take it over when the time comes. Already we're paying 'taxes' to the VC to keep our equipment on the road. Half our Vietnamese work force are VC, come to work in the morning half-asleep because they've been up all night shooting mortars, and they steal us blind. But Brown & Root don't care: they'd build bases for the devil himself if the fee was good. (p. 61)

[H: I want to interrupt here long enough to remind you of the highways and other cute construction projects in which the U.S. both participated AND footed the bill. One biggie was in Afghanistan with the Soviets—building a road right to Moscow. Another



among the MANY, was the super-road right to the doorway of Khun Sa in Shan (Golden Triangle) of Gritz fame. Yep—right to the palace doors! Your evil empire has built airfields, highways, underground complexes and other unimagined facilities all over the map. And you know what? You continue to wait for the “Fourth Reich”? You have it—some call it the “Fourth Reich” of the Rich and that isn’t a bad label—because no matter what happens with the “top dogs”—all the players get a little richer—except for the slaves and servants who just get KILLED!

If we Americans were over there really fighting Communism, as Dean Rusk says we are, (while Katzenbach, disappointingly enough, says nothing) then that in the eyes of the New Left would be a frightful thing. But if as a result of our being there the Viet Cong are going to inherit the great civil engineering works on which we seem to be doing so much better, and more successfully than we are in fighting, why then things are not so bad after all, and all the men and women of good will who so thoroughly despise the U.S. Establishment should “be heartened”, as Lydia Katzenbach says.

Lydia King Phelps Stokes Katzenbach (Mrs. Nicholas deBelleville Katzenbach) is a woman from about as pure an Establishment-supported intellectual background as you would ever want to run a file check on. Her father, Harold Phelps Stokes, Groton, Yale 1909 (Phi Beta Kappa), was a distinguished newspaper correspondent and editorial writer who once served as secretary to Herbert Hoover. His older and more famous brother, Anson Phelps Stokes, was an eminent Episcopalian divine, being Canon of Washington Cathedral for fifteen years, serving on innumerable boards, writing innumerable educational and theological books, and being cited many times in Appendix X of the publications of the House Committee on Un-American Activities for his efforts during World War II to promote Soviet-American friendship. He had lots of distinguished company, including Henry Sloane Coffin, father of Reverend William Sloane Coffin, now Chaplain of Yale—or should I say NOW Chaplain of Yale.

Lydia Katzenbach has from birth known nothing except the best Ivy League, Eastern seaboard, Establishment environment. Yet, she is something of a revolutionary-from-the-top.

Fortas and Katzenbach, who had nothing to do with the physical tragedy in Dallas, were coordinators of the *coup d’etat* in Washington which resulted from the assassination. To achieve such coordination obviously required a link with Bobby Kennedy—then Attorney General of the United States, and next of kin to the slain President. Katzenbach was plainly such a link. Fortas, older, wiser (probably), closer to Johnson (certainly), recognized Katzenbach’s indispensability in the touchy days from the *coup d’etat* of November 22, 1963 to the election of November 3, 1964. President Lyndon B. Johnson appointed Katzenbach to a four-man panel to advise him on the execution of the Commission’s recommendation.

Of Abe Fortas, *Current Biography* says:

On November 22, 1963, after President John F. Kennedy was assassinated, Fortas received an urgent telephone call from Dallas, Texas. The call was from Johnson, the first he made after the tragedy. ‘Abe,’ he

said, ‘we’re flying back. Stand by—I’ll need you.’ Fortas was at the airport to meet the plane. He was told to act as the private liaison man between the newly sworn President and Jacqueline Kennedy. (Italics added)

Not that there was anything more important than that, but Fortas was to do a great deal besides provide liaison with Jackie. His liaison with Katzenbach was pretty good also. William Manchester, in *The Death of a President*, gives details:

With the Attorney General out of action Nick Katzenbach was, in effect, Acting Attorney General, and he was proposing the investigative commission which the Chief Justice later headed. To his horror, Katzenbach learned that the new President had tentatively decided upon a Texas commission, with all non-Texans, including federal officials, excluded. **Katzenbach went straight to Abe Fortas**, the Washington attorney closest to Lyndon Johnson. He bluntly labeled Johnson’s idea a ghastly mistake [this is the man whose ‘one genius’ is knowing ‘how to handle Lyndon Johnson?'] From Fortas he heard for the first time that the President intended to release the forthcoming FBI report on the assassination the moment it was ready. That, too, would be improper, Nick argued, and *he insisted that the report be channeled through the Attorney General [Bobby] and himself.* (pp. 458-459, emphasis added.)

It would be logical that the Deputy Attorney General should be a key man in a crisis of law (which was really a crisis of power) at a time when the Attorney General was stricken with a personal tragedy. Even so, Katzenbach’s exercise of practical authority seems extraordinary. He insisted that the President do thus and so? Either directly or through Abe Fortas, how could this youngish sub-cabinet officer do that? Manchester has a tantalizing footnote to the passage quoted above: “Katzenbach took an exceptionally strong line on this issue, and like Fortas he played an unknown but vital role in the Commission’s investigation.” There is so much that is unknown about the assassination and *coup d’etat!* [H: No, that is not so—**EVERYTHING ABOUT THE ASSASSINATION AND COUP D’ETAT IS VERY WELL KNOWN AND JUST WAITING TO GET TOLD! MOREOVER IT IS GOING TO INCLUDE ABSOLUTELY EVERYBODY WHO EVEN “THOUGHT ABOUT IT” IF SOME AGREEMENTS AREN’T CONSUMMATED RIGHT QUICKLY NOW, GOOD COMMITTEE READERS. I AM ABOUT TO THE END OF THE MUSICAL CHAIRS AND SOME LAWYERS BETTER GET THEIR ASSETS IN ORDER AND THEIR PRIORITIES STRAIGHT OR NEW YORK MAY WELL LOOK LIKE THE POT-HOLES OF JUPITER. ME DO IT? GRACIOUS NO—I DON’T HAVE TO! I SUGGEST OUR “WATCHERS AND LISTENERS” GET THE WORD ON BACK, LIKE RIGHT NOW. FEET ARE DRAGGING FOR BEST ADVANTAGE AND SOON THERE WILL NOT BE DISCUSSION REGARDING ADVANTAGE FOR OTHER, BIGGER GUNS ALREADY HAVE THE ADVANTAGE!**]

There was the matter of the weird commotion in Dallas over Johnson’s taking the Presidential oath of office. When should he take it, and how should he go about it? It would be

hard to imagine a simpler legal question. Article II, Section 1, Clause 7 of the *Constitution* reads: “*Before he [any incoming President] enter on the execution of his office he shall take the following oath or affirmation:*” and the text of the oath follows. Johnson was eager to “enter on the execution of his office,” as one supposes he should have been. Tactically, he was entirely right in wanting the oath administered at once. The amazing thing is that the intelligentsia of the New Frontier did not seem to know whether he should take it at once, who should administer it, or what the wording of it was.

Katzenbach came up with the answer about the oath. Over long-distance telephone from Washington, he dictated the words from the *Constitution* to Marie Fehmer, Johnson’s secretary, aboard Air Force One, still on the ground at Love Field in Dallas. It was also Katzenbach who told Bobby Kennedy how any one of many people could administer the oath—“Anybody, including a District Court Judge... imagine...” Katzenbach said, “he’ll want Sarah Hughes.” (*The Death of a President*, p. 271.) And he did. The staunch Left-winger for whom Johnson had wangled a Federal judgeship swore him in as President.

But Katzenbach’s early activities included at least one pivotal decision more indispensable to the success of the *coup d’etat* than advice about the oath. On Friday afternoon, within hours of the fatal six seconds, a lawyer in the Dallas District Attorney’s office prepared, Manchester reports, “to charge Oswald with murdering the President as part of an international Communist conspiracy.” When Barefoot Sanders [the real name of the U.S. Attorney in Dallas] heard of it from the FBI he phoned Katzenbach, who persuaded two members of the Vice President’s [Johnson’s] Washington staff to have their Texas contacts “kill it.” (p. 287.) [H: Go read that again because I’m sure you missed the timing!]

A shrewd Yale Law School man like Katzenbach would see at once that no charge must be made of a Communist conspiracy, for that might retard the rapprochement with

GRIN AND BEAR IT / By Fred Wagner



“There isn’t a problem in this country that we can’t form a committee to study!”

Russia. But the point was even more fundamental than that. No charge must be made of any conspiracy! For it would be only too credible that if there were a conspiracy at all, especially one tagged with a Communist-connected figure like Lee Harvey Oswald, then it could be easily presumed to be a Communist conspiracy. The Communists within it could be presumed to control it. Moreover, the Communist Party itself is conspiratorial in character, and if any one of its functionaries becomes involved in a special plot then he involves all Communists. Not just the government of Russia, but also all American Communists—Guss Hall, and (more important) Alger Hiss and all the undiscovered but potentially discoverable other Alger Hisses in America. The possibility of any conspiracy must be eliminated!

Law professor Nicholas deB. Katzenbach probably knew as much about the law of conspiracies as did Judge Irving R. Kaufman, whose instructions to the jury in the trial of Julius and Ethel Rosenberg, (notorious atomic spies) constitute for the layman one of the clearest expositions on the subject. I think extended quotation from Judge Kaufman's charge to the Rosenberg jury is justified in emphasizing how necessary it was in November 1963—necessary to survivors of the *coup d'etat*—that there be no talk of a conspiracy. Judge Kaufman said, in part:

For two or more persons to conspire, confederate or combine together to commit or cause to be committed a breach of the criminal law of the United States is an offense of grave character which involves a plotting to subvert the law. *It is almost always characterized by secrecy, rendering detection difficult and requiring much time for its discovery. Because of this the statute has made a conspiracy to commit a crime a distinct offense from the crime itself.* [Italics added]. From the point of view of the law there is danger to the public when two or more people conspire to do something that is unlawful because by virtue of the aggregation of numbers the intent assumes a more formidable disadvantageous aspect to the public.

What is a conspiracy? A conspiracy may be defined as a combination of two or more persons, by concerted action, to accomplish a criminal and unlawful purpose, or some purpose not in itself unlawful or criminal, by criminal or unlawful means. The gist of the offense is the unlawful combination or agreement to violate the law. As Mr. Justice Holmes said many years ago: 'A conspiracy is a partnership in criminal purposes.' [H: I might add hereat that all parties to a conspiracy are not required to know of the direct intent of the conspiracy—one can become part of a conspiracy simply by default or presence.]

However, *it is not necessary in order to constitute a conspiracy that two or more persons should meet together and enter into an explicit or formal agreement for an unlawful scheme, or that they should directly, by words or in writing, state what the unlawful scheme was to be, and the details of the plan or means by which the unlawful scheme was to be made effective.* [Italics added]. This whole passage implies, among other things, that a person may be part of a Communist conspiracy, or

of the Communist conspiracy, without ever at any time being recorded or recognized formally as a member of the Communist Party.]

[H: Now for our own attorney "minds": It is obvious that you are missing a lot of interesting ammunition in your battle against Mr. Abbott, et al. (Green Brigade). When an attorney moves into a case in which he is not a participant in direct integration (i.e., Abbott/Fort) the responding in legal case filings when the case was not set forth TO/WITH the parties represented (Horton/Green) then you have the PRESUMPTION OF CONSPIRACY. FURTHER, IN THE CIRCUMSTANCE OF MR. TIPS' EFFORTS TO GAIN RELEASE OF COURT-ORDERED VOLUMES TO BE RELEASED TO MR. GREEN, EVEN THOUGH TIPS ACTED IN GOOD FAITH—HE BECAME A PART OF THE CONSPIRACY WHEN HE ENTERED FILINGS OR NEGOTIATIONS IN BEHALF OF GREEN WHEN HE NO LONGER ACTUALLY REPRESENTED GREEN! GREEN HAD MADE HIS AGREEMENTS AND HAD ARRANGED FOR ANOTHER ATTORNEY—WHO IN TURN, WAS NEVER RELEASED LEGALLY FROM HIS CONFLICT OF REPRESENTATION WITH OTHERS NAMED IN THE ORIGINAL SUIT. FURTHER, BE ALLOWING THE JUDGE TO CITE EKKERS FOR CONTEMPT OF COURT WHEN ANY SALES AND PROCUREMENTS OF BANNED BOOKS WAS ON THE PART OF FIRST DEFENDANT, GREEN, CONSTITUTES FURTHER ASSUMPTION OF CONSPIRACY WITH GREEN. NO, I AM NOT NUTS—I KNOW THE LAW! TOO BAD THE ATTORNEYS AND LAWYERS IN ACTION TODAY ARE ONLY LEARNED IN WHAT THE BAR ASSOCIATION DEEMS APPROPRIATE IN A CORRUPTED ADMIRALTY COURT.]

It is sufficient if two or more persons, in any manner, or through any contrivance, impliedly or tacitly, come to a mutual understanding to accomplish a common and unlawful design, knowing its object, and that one or more of them commit an overt act in furtherance of the conspiracy. In other words, *where an unlawful end is sought to be effected and two or more persons, actuated by the common purpose of accomplishing that end, knowingly work together in any way in furtherance of the unlawful scheme, every one of said persons becomes a member of the conspiracy, although his part therein be a subordinate one, or be executed at a remote distance from the other conspirators.* (Printed Transcript of the Rosenberg Trial, pp. 1550-1551, Italics added.)

[H: I would hope that somebody makes Mrs. Eleanor Schroepfer and Leon Fort, along with Luke Perry and other involved parties with Mr. Green—aware that this is the very basis of any problems arising from your activities regarding the "Institute". You demanded, number one, that which was not entered into as agreement by personal entities—but rather through corporate regulations. Then, continued to conspire to destroy a corporation and, in fact, a corporation which was once jointly headed by one George Green. THE LAW demands fiduciary responsibility, under penalty of that law, to act in good faith and cause to defend said corporation. Parties who happen to be in

opposition to your "druthers" are bound by those laws whether or not it pleases YOU. Further, it did not end at that point—there was CONSPIRATORIAL effort in mass amounts to keep Mr. Schroepfer from being allowed to have visitation with anyone—in an effort to hide ongoing conspiracy efforts. There has been continued CONSPIRACY attempts to bring the "Institute" into receivership and force bankruptcy—ACCORDING TO ALL DOCUMENTS SENT FORTH IN MASSIVE NUMBERS BY MR. GREEN—NAMING ALL OF YOU NICE PEOPLE IN EVERY MAILING. NOW, IN VIEW OF EVENTS ONGOING—IT HAS TO BE ASSUMED IT IS NOW AN INTENTIONALLY ENTERED-INTO CONSPIRACY—AND NOT SIMPLY IMPLIED PARTICIPATION BECAUSE OF IGNORANCE OF ONGOING EVENTS.]

As you see, the Law, which often seems to go after individual criminals like a very sporting flycaster, drags with a seine when it fishes for conspirators. To the philosophy expressed by Judge Kaufman above, which makes it not difficult but easy to prove that so-and-so is a Communist or any other kind of conspirator you want, we must add the fact that evidence which in other cases would be ruled as hearsay and inadmissible, is in conspiracy cases ADMITTED AS PROBATIVE.

Deputy Attorney General Katzenbach realized immediately on learning of the tragedy in Dallas that not only must there be NO talk of a conspiracy, there must be an official finding that there was no conspiracy. [H: Back to the old assumption: "Until a thing is officially denied, we cannot be sure of its truth." Well, how long have George and conspirators DENIED involvement? Good grief, what is the matter with your attorneys? OR, IS "THAT" WHAT IS THE MATTER WITH YOUR ATTORNEYS? DO THEY THINK YOU WILL NEVER KNOW THE TRUTH? OR THE LAW??] If a conspiracy were posited in an affair of such tremendous public importance as the assassination of a President, when would the work of prosecution ever end? And who, among those who might have been in any way involved or suspected of having been involved, could ever again rest easy? As Judge Kaufman said, a conspiracy is "characterized by secrecy, rendering detection difficult and requiring much time for its discovery." [H: Sort of like burying the gold in the back yard?] The other side of that coin is that much time and great effort would be devoted to its discovery. There is no statute of limitations on murder, and people would never become bored with the murder, and the implications of the murder, of President John F. Kennedy.

Prevention of an indictment in Dallas referring to an "International Communist Conspiracy," which the sensitive William Manchester calls a "canard", was for Nicholas deB. Katzenbach only a preliminary to getting the Warren Commission established. There is much that is obscure about the birth of this Extraordinary Commission—its parentage, the midwives, and so forth—but one thing is certain: Katzenbach was in the obstetric ward when the Warren Commission was delivered. Little else could have made him so nearly indispensable to the Johnson Administration. New Leftists who do not understand this and who attack the Warren Commission do not understand very much.

[END OF QUOTING]

Let us interrupt here and take up at this same topic point when we next write on this subject. Thank you for your attention—I hear you, it is “finally” getting interesting! So stay tuned. Salu.

7/20/94 #2 HATONN

THE USURPERS, Part 10
(Continued)
by Medford Evans

[H: Who is Medford Evans? He is a Ph.D. (Yale 1933), was Chief of Security Training for the United States Atomic Energy Commission in 1951-52. He is also the author of THE SECRET WAR FOR THE A-BOMB. Sorry to be so late in offering this information.]

THE OPERATORS
KATZENBACH

[QUOTING:]

Katzenbach understood. He was quick to see that Lee Harvey Oswald, before Jack Ruby made his contribution to history, probably could not get a trial which would stand up on appeal in any court in the country. For the nation had seen and heard so much on TV during those forty-eight hours in which Oswald survived Kennedy that no impartial jury could have been found. Manchester reports that by Friday evening, within hours of Oswald's arrest, Katzenbach “began to entertain serious doubts that any conviction of the suspect could survive appeal.” Katzenbach saw that. It was Jack Ruby who did something about it.

After Ruby's work was done, there was no way of bringing Lee Harvey Oswald to trial, fair or unfair. Since he died without having been convicted, he must have been, under the Law, presumed innocent when he died. Immediately upon his death, however, there was little or no hesitation in speaking of him as the “murderer” or as the “assassin”. This was not merely journalistic license, taking advantage of the fact that a dead man cannot sue for libel and his family are not likely to do so. The belief that Oswald was guilty, and he, solely, guilty, became an essential article of faith for those in the orbit of the Establishment. [H: How are we doing so far, Ronn Jackson?]

A trial in the Anglo-American tradition is a contest of adversaries—prosecution and defense. The accused is entitled to counsel, his counsel has status as an officer of the court, but has no other responsibility than to represent the accused to his greatest available advantage. One assumes it is not to his advantage to lie to the court, but he does not have to testify against himself. The spouse of the accused is not admitted to testify either for or against him. He has a right to confront his accusers, and to have his counsel cross-examine them. And he is presumed innocent until proven guilty. In other words, the whole original burden of proof is on the prosecution. There are other restrictions on procedure. The system is widely regarded as the fairest application of the Law so far developed in the history of human society.

Reviewing the available record at this time, it is doubtful in the extreme whether the prosecuting attorney in Dallas could, under this adversary system, have convicted Lee Harvey Oswald of the murder of John F. Kennedy, except by appeals to the emotions of the jury

and other methods which would have embarrassed any appellate court, including the Supreme Court. Katzenbach's fears were well grounded.

But what could hardly have been accomplished under the adversary system of trying a case might be, and was, readily concluded by a court of inquisition—the Warren Commission. In the United States, so far, an inquisitorial body can try only dead men. An inquisition has many advantages over a trial court—advantages, that is, in reaching a predetermined, and thus unfair, conclusion. They are not advantages from the point of view of the accused. An inquisition may admit whatever evidence it chooses—hearsay, testimony of a spouse, expressions of opinion from any source.

The most damaging testimony against Lee Harvey Oswald was that of his wife Marina, who could not have testified at all if her husband had been alive, but who, since he was dead, was the first witness called by the Warren Commission. Marina Oswald testified to the effect that Lee Oswald shot Kennedy, something she could not have really *known*, but she was protected by the Warren Commission from cross-examination. Before she went before the Commission, she appeared on television, to say, among other things: “I don't want to believe, but I have to watch facts, and facts tell me that Lee shot Kennedy.” After that, the conclusion of the Warren Commission was inevitable as to Oswald's guilt; the reasons he

could not be allowed accomplices we have already touched upon.

Marina Oswald was well protected. Chief Justice Warren ruled, after her TV appearance and before her performance at the inquisition, that there would be no “defense counsel”—no lawyer to represent the interests of the deceased, no adversary for the Commission's Counsel, J. Lee Rankin, who had fourteen lawyers for Assistant Counsel plus a professional staff of twelve. Later in the procedures, after Marina Oswald's dramatic first appearance, Walter E. Craig, president of the American Bar Association, was asked to keep an eye on proceedings to insure that they “conformed to the basic principles of American justice”. He was a very tame adversary, if adversary he was, for he did so little and his name does not even appear in the Index of the Warren Report. Even so, he was not admitted as umpire, referee, or whatever, until Marina Oswald had set the stage for the inevitable denouement.

“The most striking element in the encounter of the Russian widow and the U.S. Chief Justice was Warren's solicitude regarding her,” writes Leo Sauvage, who also reminds us that until Mrs. Oswald was adequately prepared for her public appearances she remained in the custody of Deputy Attorney General Nicholas deB. Katzenbach.

It should not be forgotten that the Justice Department of which Katzenbach was the operating chief in 1964, was in substantial control of the Warren Commission's activities, though

THE WORD

Tapes, Transcriptions & Videos

In addition to audio tapes of meetings with Commander Hatonn and written transcriptions of some taped topics, **THE WORD** also offers other tapes and videos on selected topics.

Donations to cover the costs of tapes are \$4.00 for one tape, \$6.00 for two tapes and \$2.50 per tape for three or more, except where otherwise noted. The transcriptions are \$3.00 each. (Mexico or Canada add \$0.25 and other foreign countries add \$0.50 per tape or transcription.) Postage is included in tape and transcription prices.

Please send check or money order to: **THE WORD**, P.O. Box 6194, Tehachapi, CA 93582 or call 805-822-4176 if you have questions or you wish to use your Visa, Discover or Master Card.

If you desire to *automatically* receive tapes from future meetings, please send at least a \$50 donation from which tape costs will be deducted. We will try to notify you as your balance reaches zero.

Special Order tapes are noted below by * and are not automatically sent since this material is usually either already in print or will be soon. Available written transcriptions are noted by #.

The following is a *partial* list of older items but including all of the most current meeting dates, with the number of tapes in bold, in parentheses, and mentioning if the meeting has a special focus:

4/13/92(1) # “What Is A Semite?”;	Soltec with Hatonn;
4/17/92(1) # “Who Were The First Christians?”;	4/4/93(3) including Soltec and Sananda;
4/25/92(2) # “The Photon Belt”;	4/10/93(2) radio program KTKK;
4/26/92(3), 5/1/92(1) “L.A. Riots and The Bigger Plan”;	4/24/93(3); 5/2/93(2); 5/16/93(2);
5/11/92(3) * “Silent Weapons For Quiet Wars”;	5/23/93(3), 6/20/93(2);
5/30/92(3) * “The Divine Plan and places In Between”, tapes 1-3;	6/20/93(1)*Mystery Virus in New Mexico
6/28/92(2) radio program, KTKK, Salt Lake City, UT;	7/2/93(2)* Rayelan Russbacher on KTKK;
6/30/92(3) * “The Divine Plan and places In Between”, tapes 4-6;	7/11/93(3); 7/18/93(2); 7/30/93(3);
8/31/92(2) Anti-Christ Banksters;	7/31/93(1) KTKK Little Crow;
12/31/92(1) * Constitutional Law Center;	8/8/93(2); 8/21/93(2);8/29/93(2);
1/2/93(2);	8/22/93(3) Gunther Russbacher interview;
1/14/93(2) Seminar speech by Retired Police Officer Jack McLamb;	9/5/93(3); 9/14/93(2); 9/19/93(3);
1/16/93(2); 1/23/93(3); 1/30/93(2);	10/9/93(3); 10/16/93(3); 10/30/93(2);
2/6/93(1); 2/13/93(2); 2/18/93(2);	11/13/93(2); 11/21/93(3); 11/27/93(2);
2/20/93(2) radio program on KTKK featuring	12/5/93(2); 12/12/93(2); 12/18/93(1);

VISA, DISCOVER AND
MASTER CARD ACCEPTED

#1-#5 Corporation Lectures (\$5 each tape).

the State Department, Treasury Department, and Central Intelligence Agency also had a hand in it. These agencies did all the investigative work. The FBI, which is part of the Justice Department, did most; the Secret Service, which is in Treasury, did next most. Abe Fortas, at the time a lawyer in private practice, was the key link to the White House; Katzenbach was the main channel to the bureaucracy. These two, as it appears from Manchester and others, were in effective working relationship with each other.

The Warren Commission, with all the vast machinery at its command, did not want to know the truth, though it must have known much of it; nor did the White House and the great executive departments want the Warren Commission to know the truth.

Author Leo Sauvage has something interesting to say at this point. Sauvage, correspondent in America for the Parisian journal *Le Figaro*, once stood high in the esteem of the polite Left, having written for *The Reporter*, *The New Leader*, and *Commentary*. He is a talented writer and industrious investigator. But Sauvage had trouble publishing his book on the assassination because his views did not coincide with those of the Warren Commission. His book, *The Oswald Affair*, was eventually published by World Publishing Company.

As Sauvage points out, had the Warren Commission really wanted to know the truth, the first thing the commission would have done would have been "to reconstruct some kind of acceptable substitute" for all the documents that were not prepared in Dallas the day of the murder. For, the most incredible thing is that there is said to be no transcript of the police interrogation of Oswald between the time of his arrest, Friday afternoon November 23, 1963, and the time of his execution by the lone vigilante, Jack Ruby, some forty-five hours later, on Sunday morning, November 25, 1963. To piece out such alarming gaps of information should have been, Sauvage contends, and it is hard to disagree, "Task Number 1 for the Commission". Instead,

...it appears that the Commission's idea of Task Number 1 ...was... to give Marina Oswald, who could not have been admitted legally as a witness before Judge Brown in Dallas, the opportunity to accuse her husband before the Chief Justice of the United States (p. 139).

Marina Oswald was not only the first witness to appear before the Commission (February 3, 1964), she was also the last (September 7, 1964). She gave the original impetus and direction; she gave the final clearance. Her influence is suggested in a striking passage in Edward Jay Epstein's *Inquest*. The Commission's legal staff, according to Epstein, felt that her testimony in February "contained obvious contradictions and inconsistencies," and thought she ought to be recalled and cross-examined. One of the lawyers, Norman Redlich, wrote in a memorandum:

Marina Oswald has lied to the Secret Service, the FBI, and this Commission repeatedly on matters which are of vital concern to the people of this country and the world.

But Earl Warren is, in his own way, a resolute character. Chief Counsel J. Lee

Rankin reported, says Epstein, "that the Chief Justice considered himself to be 'a judge of human beings', and he and the other Commissioners fully believed her testimony."

That Marina Oswald be called as the first witness was suggested in a memorandum prepared December 28, 1963 by Howard Willens, vigorous young Yale Law School alumnus assigned by Katzenbach the job of liaison between the Commission and the Department. One psychological effect was to eliminate from the area of public speculation the possible involvement of others in the assassination, to eliminate, by dwelling on domestic details of the poor and unhappy Oswald household, the very thought that the assassination was part of anything so significant as a *coup d'etat*.

In the main, that thought has been eliminated. Critics of the Commission who reject the proposition that the obscure Oswald by himself killed the President tend to suggest that several other equally obscure persons were involved. It is felt to be inappropriate, and perhaps risky, to remember that it was not any obscure person nor a collection of obscurities, but Brutus and twenty other eminent Romans who killed Caesar.

Jackie Kennedy was quite right, at least emotionally, in rejecting the thought that her husband had been killed by some "silly little Communist". [H: Well, now Jackie, it beats having "committed suicide" right there in public—which it undoubtedly some day will publicly be stated.] He wouldn't have been killed by a silly little anybody. He MUST have been killed by MAKERS OF HISTORY, whoever they were. They could, to be sure, have been serious "big" Communists. For this reason it seems very strange that Jackie Kennedy should, on December 1, 1963, nine days after her husband's death, have written a personal letter to Nikita Khrushchev—a letter of gratitude and respect, a letter referring to, among other things, Khrushchev's "kindness... in Vienna". But—although Manchester's *The Death of a President* was a best seller, and although it includes the full text of Jackie's letter to Khrushchev—few people seem to know that President Kennedy's widow so promptly communicated with the man who was taken to be her husband's adversary on the other side of the Iron Curtain.

Even if history should eventually show that the shooting in Dallas November 22, 1963 was a special kind of urban guerilla warfare, in which the target was not a fireman or policeman but the President of the United States, and in which the purpose was not to produce temporary chaos but a permanent new order—even if the essential facts of the *coup d'etat* come to be known and accepted, and all the falsehoods of the Warren Commission mercilessly exposed—yet still it will remain true that planning, principally in the Justice Department under Deputy Attorney General Katzenbach, *delayed* speculation about a conspiracy long enough to insure Johnson a landslide election in November 1964.

It would, of course, be absurd to say that the Warren Commission participated in the assassination of President Kennedy. Unfortunately, it is not at all absurd to say that the Commission, and President Johnson, whose Commission it was, are accessories *after the fact* in the murder of John F. Kennedy. The reason that shocking statement is not absurd is simply that we now know for a reasonable certainty—the book *Six Seconds in Dallas*, by Josiah Thompson knows it, if Edward Jay

Epstein knows it, we may also be reasonably sure that the Commission knew it.

But if the Commission knew that Oswald could not have been a lone assassin, and yet published the conclusion that he was, then the Commission was aiding the others—whoever they were—to escape. [H: Now you come to a really hard one to swallow, thinkers in truth—at the time of the Warren Commission—guess who was not only head of the Warren Commission but also A-1 of the Committee of 16? I think you'll be real close if you guess, Earl Warren! Are you beginning to see just how handy it is to HAVE POWER?? I believe, further, that this also indicates as head of that Commission—that he was also Chief Justice of your highest judicial system in supposedly, the world—The SUPREME COURT! If all this did not take place at the same time, which I do not have any desire to look up—but Jackson can do so FOR you—then it was damned close! Is Earl Warren really gone? Let's just say that it doesn't matter—he certainly is NOT forgotten.] And this, I believe, is what is meant by the term: accessory after the fact. The charge, implicit here and in numerous other books, that the Warren Commission was lying is so shocking that many good citizens are reluctant to think about it. Some who do think about it search for plausible defenses of the Commission. It has been said that the Commission must have been telling the truth because the investigative resources of the Department of Justice were under the command of the dead President's brother. Bobby Kennedy was Attorney General throughout the working life of the Warren Commission. The answer to that is that Bobby Kennedy depended at this time on Katzenbach to run the Department. Katzenbach, as we have seen, was the first government official to propose the Extraordinary Commission which became known as the Warren Commission. It was set up with remarkable speed. The President's Executive Order 11130 which created it was issued November 29, 1963, one week to the day after the assassination. Even more remarkable was the speed, and the parallel thinking, of the Communist tabloid paper, *The Worker*, which on Tuesday, November 26, 1963, published its demand that just such a commission headed by none other than Chief Justice Earl Warren be appointed by President Johnson.

That Katzenbach was so largely responsible for the creation of the Warren Commission, and the Warren Commission was essential to the political security of the Johnson Administration, explains as well as anything could the "genius" Katzenbach has for knowing "how to handle Lyndon Johnson."

Katzenbach is today, of course, the Under Secretary of State—which means that he is the alter ego of Dean Rusk, LBJ's mentor in foreign affairs. Considering Katzenbach's former alter egoism for Bobby Kennedy, idol of the New Left, and implacable foe of LBJ, we have a seeming paradox—unless we recognize Katzenbach for the link that he is between the New Left and the old.

7/20/94 #3 HATONN

THE USURPERS, Part 11
by Medford Evans, Ph.D.

THE SCHEMERS

ROSTOW, FORTAS, CLIFFORD

A "schemer" is basically not an organizational man, though he necessarily works *through* organizations, and sometimes *in* and *for* an organization. Essentially, however, he is a loner. He thinks of other men as resources, and the coolness of his calculations breeds in the others a curious amalgam of respect, admiration, distrust, and alienation. The Schemer is never a great commander or charismatic leader, and he himself is aware of this; he may suggest or control all or nearly all of the leader's actions, but he cannot take such action himself, for he will not be followed.

Since the Schemer lives by his wits, he has wit enough to appreciate the advantages of his own position, which is much freer than that of the commander, and this appreciation prevents his wasting time being jealous of the nominal superior to whom he furnishes ideas and methods. After all, it is rather fun to be a kingmaker, and to pay for the pleasure by yielding all the more splendid perquisites to the king is not a bad bargain. Besides, the comparative obscurity of the moment may be recompensed in the light of history. Hamilton is nearer to Washington in public esteem now than when both lived; Colonel E. M. House is gaining on Woodrow Wilson in fame since their time.

Three men—Walt Rostow, Abe Fortas, and Clark Clifford—have this in common: they are Schemers. Each has what Murray Marder of the *Washington Post* has described in Doctor Rostow as "a mind which formulates ideas in series of problems and answers." Until Clifford became Secretary of Defense, no Schemer had ever assumed major executive responsibility. Schemers are fixers, they are troubleshooters. Heaven knows there is plenty to fix.

Rostow is an academic, a Ph.D. from Yale. Fortas and Clifford are lawyers. Fortas has an LL.B. from Yale Law School. These men are all gifted with keen analytical intelligence. Rostow, being apparently more a theorist than the other two, may have developed more bias for his own theories, but on the whole all three seem to have the ability to examine with cool detachment a situation into which, with proper inducement, they are ready to throw themselves with great force and determination. They are professionals.

WALT WHITMAN ROSTOW

Walt Rostow has an academic cover—he is an old hand at undercover intelligence work—OSS during World War II, a big CIA assignment while ostensibly teaching at MIT in the 1950s. Together with an MIT colleague, engineer Jerome B. Wiesner, Rostow went to the "Pugwash" conference in Moscow in November 1960, where he talked with V.V. Kuznetsov of the Soviet Foreign Office.

The Pugwash conferences are get-togethers for Russian and American nuclear scientists, paid for by the self-professed admirer of Communists, financier Cyrus Eaton. Originally the conferences were held at Eaton's posh summer estate at Pugwash, on Northumberland Strait, in Nova Scotia, Canada. By the sixth conference in November 1960 the spirit of international fraternity among the scientists was strong enough to result in a Moscow meeting. It had been immediately preceded by another conclave which Doctor Rostow attended also—"a series of closed meetings". *Current Biography* says it

was comprised "of American and Soviet intellectuals held at Dartmouth College... under the sponsorship of the Ford Foundation." Apparently, the scientists and intellectuals so fear an open society, so need secrecy, that they find it necessary to hold "closed meetings" at which a highly elite group of Russians and Americans share sublime thoughts while 200 million dumb American "laymen" and a greater number of mulish Russian muzhiks and cynical Russian proletarians are excluded because they would not understand the technicalities and might understand all too well the politics involved in the discussions.

Rostow and Wiesner returned from Moscow prepared to guide White House policy on nuclear disarmament, and have pretty well done so ever since. Rostow told the late Marguerite Higgins of the now defunct *Herald Tribune*, when she asked him in July 1960 some question about the then Senator and Presidential candidate John F. Kennedy, "Jack and I hit it off from the start." This brashness may account for the reservation which Arthur Schlesinger says Dean Rusk showed toward Rostow when Kennedy was filling key jobs just before the President's inauguration.

Rusk did not want Rostow in the State Department, says Schlesinger (*A Thousand Days*, pp. 124-125.), and Kennedy settled for making the OSS-CIA veteran a Deputy Special Assistant (deputy to McGeorge Bundy) for national security affairs. Later, Rostow got the job of policy planning chairman in the State Department after all. One wonders why Rusk gave in. But, today, under Johnson, Rostow is back in the White House itself, not now as deputy, but in Bundy's place as the Special Assistant to the President for national security affairs. Bundy went to the Ford Foundation. [H: Keep it all in the Committee!]

Dean Rusk's reservations about Rostow might very well stem from considerations of style. Rusk himself, while strategically audacious, is suave—deceptively deferential, even—in his manner; he wouldn't have called Kennedy *Jack*, he certainly doesn't call Johnson *Lyndon*, he probably doesn't even call Rostow *Walt*. But the two of them would not be basically at odds. They are in it all the way together—with Johnson, with Fortas, with Clifford—in the project in Socialist reconstruction in Vietnam.

Rostow would not compare with Clifford or Fortas as a Schemer in the area of domestic politics—he does not begin to understand ordinary Americans as they do. On the other hand, he has more knowledge of Europe (probably also of Asia) than Fortas and Clifford do, and he is part of the "intellectual community" in a way that they can never be.

Fortas and Clifford may well be more *intelligent*, in every meaningful sense of that term, than Rostow, but belonging to the "intellectual community" sometimes has surprisingly little to do with intelligence. In one of Rostow's books, *The United States in the World Arena*, he has written:

It is a legitimate American national objective to see removed from all nations—including the United States—the right to use substantial force to pursue their own interests... it is, therefore, an American interest to see an end of nationhood as it has been historically defined (p. 549).

This clearly threatens the continued existence of the United States. Yet it is doubtful whether Doctor Rostow could be convicted of

treason, even if he had been observed in overt acts to further the national suicide which he says is "an American interest", or had been observed "adhering to their [the United States'] enemies," (as the *Constitution* provides must be done to sustain a treason charge). The 1960 Moscow meeting of Rostow, Wiesner and Kuznetsov was quite evidently not a parley at arm's length as is proper between hostile powers, and indeed Rostow and Wiesner had no diplomatic credentials to represent the Government of the United States. They were giving free advice to a high-ranking Soviet diplomat on how best to deal with diplomatic representatives of the United States—on how best to achieve Soviet purposes. Only the argument that the Soviet Union was not an enemy—an argument which makes nonsense of Cold War history and of such organizations as NATO—could seriously trouble a prosecutor who wished to build a case of treason against Rostow and Wiesner. Famed defectors Burgess, McLean, and Philby could not have told the Russians as much, for they did not know as much.

The defense of Doctor Rostow and Dean Wiesner—in practice an adequate defense against charging them with treason—is that they are simply typical of the Liberals whose principles have dominated policy these past thirty years not only in the United States but throughout the Western world. Edmund Burke said, "I do not know the method of drawing up an indictment against a whole people," and the Liberals are a whole international class of people—far along in bringing about the "suicide of the West", as James Burnham has so lucidly set forth in his book by that title. The pity is that, numerous as they are, Liberals are a small minority of the entire population of the United States and of the West. Yet by their power, which is largely due to the prestige of their supposed intellectual attainments, the Liberals are taking the majority down with them.

Doctor Rostow is, of course, an economic determinist which is to say he is some kind of Marxist. A Communist is some kind of Marxist, too. What is said to be his most influential

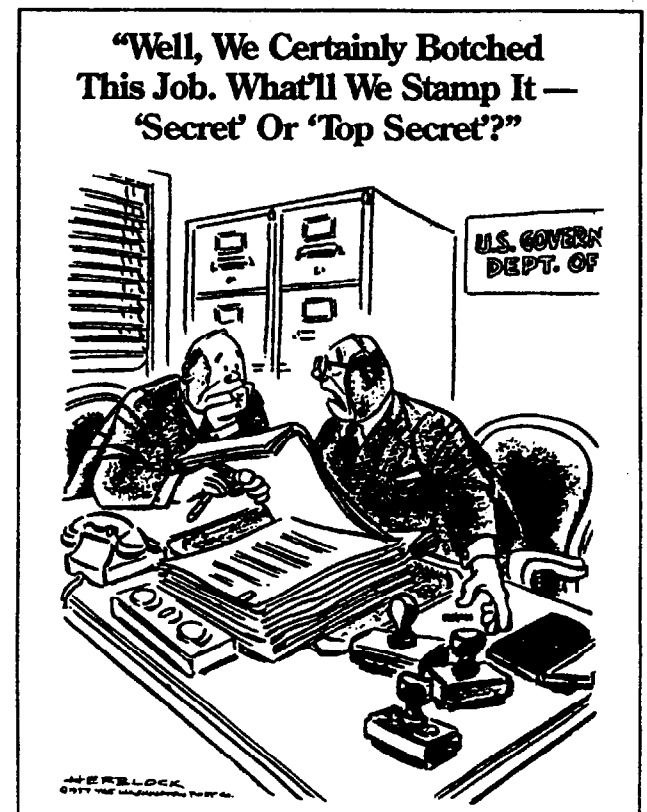

book, *The Stages of Economic Growth*, extrapolates from Marx the curve of social development. Rostow postulates five "stages" in the life of any continuing society: (1) the traditional society, (2) the preconditions for takeoff (this term may be his chief addition to Marx, who died before the airplane was invented), (3) the takeoff, (4) the drive to maturity, (5) the age of high mass consumption. In the fifth stage, where there is enough of the world's goods to satisfy all, the state, if it does not wither away, can at least be transformed into a management staff, concerned with production "from each according to his ability" and with distribution to each according to his need. Such a state will be nonaggressive. In the United States, we are approximately in the fifth stage. The Soviet Union can be expected confidently to enter the same stage at any historical moment now. It would then, this Schemer seems to say, be desirable for the United States and the Soviet Union to merge. In the meantime, according to Rostow, our proper stance is indeed one of readiness to prevent the Soviet Union from hurting us, or at least to minimize such hurt, but above all one of vigilance to prevent reactionary elements in our own society from—say through reckless use of nuclear weapons—destroying the rapidly maturing Soviet society. Indeed, we must do everything possible to help the Soviet Union—and, of course, all other societies as well, particularly those of "underdeveloped countries." As part of their development, part as it were of their "national adolescence," the underdeveloped countries have not reached the stage where *they* should do away with nationhood. These societies may break out into a kind of collective juvenile delinquency, which we are to contain and tolerate as well as possible, while continuing to give them every fundamental kind of assistance. We are to be Big Brother to the world—until one day the world is one, with policies planned by the Rostows of the future—who, if geriatrics is successful, may even be the Rostows of the present! Let's consider another way of looking at the Schemer's apparent line of reasoning.

A Big Brother (USA) who is attacked by his Little Brother (USSR) takes measures to defend himself, and may even give the kid a thorough workout, a pretty fair working over. But Big Brother fighting Little Brother always to some extent pulls his punches. Big Brother does not seek *victory*. Big Brother wants to see Little Brother grow up to be as much of a man as he is himself. When that time comes, the two will surely be friends as well as brothers. Meanwhile, though boys lose their tempers with men, men do not lose their tempers with boys. Teach the kid a lesson, but take it easy, don't really hurt him.

What consummate conceit! No wonder Russian and especially Asiatic Communists do not return the love which American and West European "Liberals" proffer! There is in the Western attitude an arrogant presumption of superiority (imagine a Chinese trying to digest the thought that the United States is a more mature country than China!) which must be far more infuriating than any flat declaration of hostility could be.

Unfortunately, some such presumption underlies our whole operation in Vietnam of which Doctor Rostow is one of the chief Schemers.

Doctor Rostow is a *strategic* pacifist, since he envisions a disarmed world where fully

mature societies live, without "nationhood", in his euphoric fifth stage of high mass consumption. But Doctor Rostow is no *tactical* pacifist. Arthur Schlesinger Jr. writes that Rostow's "combination of the spacious historical review with a passion for counter-guerilla warfare caused much joking about his being 'Chester Bowles with machine guns', all of which he took with gentle tolerance." (*A Thousand Days*, p. 353.) By 1967 many Liberals were no longer joking about the matter, and a somewhat shook-up Mary McCarthy was referring to "the sinister Walt Rostow, and now to be closest to the cupped Presidential ear." (*Vietnam*, p. 62.)

I gather that Mary McCarthy thinks Walt Rostow has sold out to the military-industrial complex—or somebody who wants to make money and get increased power out of the Vietnamese War. I suspect that Mary McCarthy, subtle writer though she is, has not penetrated to the reaches of thought where Walt Rostow has concluded that a large-scale military operation in Vietnam—*provided it is equipped with a governing device to prevent the military from seeking a "military solution"—i.e., victory*—can contribute enormously to the economic growth of Southeast Asia and eventually of China, advancing the day when high mass consumption will replace the incidental and almost random killing which we must expect for a while from both the Viet Cong and our own troops.

Walt Rostow is an action-type intellectual. In this he bears comparison with the New Left. Unlike them, however, he is not interested in theatricals, and more completely than Katzenbach he chooses to work within, and through, the bureaucracy rather than against it. He influences official policy all he can, but is evidently determined to identify himself with it, whatever it is. And how else could he stay in the White House? He has been identified with official policy, both under Kennedy and under Johnson—conspicuously so—since he was sent with General Maxwell Taylor in October 1961 to survey the Vietnamese situation and make a report to Washington. It was in pursuance of that report that the American buildup in Vietnam began.

Rostow's—and Taylor's—influence has never ceased to be felt in the *type* of fighting we do in Vietnam. It may be remembered that the Office of Strategic Services (OSS) in World War II was a paramilitary outfit, and Walt Whitman Rostow attained the rank of major in the OSS. As a logical consequence of that experience, "guerrillas were", as Arthur Schlesinger puts it, "an old preoccupation of Walt Rostow's". As a special case of Maxwell Taylor's "Doctrine of Flexible Response", which among other things means *don't use nuclear weapons unless the other side uses them first*, Rostow urged upon Kennedy a new emphasis on "counterinsurgency", Special Forces, and "unconventional warfare"—phrases which mean a willingness to cut throats at night and build bridges in the daytime, just like the Viet Cong. Schlesinger says that in the wake of recommendations by Rostow, Taylor, and others, and after reading Mao Tse-tung and Che Guevara for himself, President Kennedy "insisted that the Special Forces be schooled in sanitation, teaching, bridge-building, medical care and the need for economic progress."

The whole policy amounts to: in-

troductory into Asia of the most advanced methods of socialistic reconstruction and development, coupled with an absolute veto of the most advanced methods of waging a victorious war.

In the tug-of-war between United States officers who would like to win in the field in Vietnam and Schemers in Washington, such as Rostow, who want to stay in the field but avoid victory, there has developed the fantastic use of the helicopter. Ask yourself, for you don't have to be a military expert to know the answer, how long a helicopter would last in a war against a well-equipped enemy. The fact that, prior to the North Vietnamese February attack with Soviet tanks, helicopters had been the outstanding success of our operations in Vietnam, shows as clearly as anything could that the enemy was not well-equipped. *In any case, it must take managerial skill of the highest order in the White House and the Pentagon to keep our military from winning in Vietnam!*

The helicopter is a police weapon. It is perfect in situations where massive firepower cannot be directed against you; it is a hovering duck against such firepower. A helicopter military attack on an armed city would be suicide for the attackers. In contrast, helicopters over a city in peace are an admirable means of intimidating and controlling motorists or other civilians who have no anti-aircraft weapons. This is perhaps a minor illustration of the fact that the whole counterinsurgency program and method of fighting in Vietnam *condition our troops to control civilian populations*. Moreover: *It should be remembered that if we have not subdued the Viet Cong, we have certainly subdued all the South Vietnamese except the Viet Cong!*

The American presence in Vietnam is one part stimulus to economic growth of all East Asia, one part counter-guerilla warfare, and one part internal police for the area. All three of these are special interests of the brilliant theoretician, Walt Whitman Rostow.

[H: I really don't think the major reason for the war is lost on this author—but I surely don't want it lost on YOU. The war was a MAJOR TESTING OF THE MIND-CONTROL TRAINING AND PROGRAMMING—AND THE PROTECTION AND STRUCTURING OF FURTHER BUSINESS IN ARMS AND ESPECIALLY IN DRUGS! Another major item in this little experience was to see how far ordinary soldiers would go to follow orders and/or simply kill innocent civilians—women and children. I think the results proved that they would do anything for anybody without much hesitation if triggered by authority to do so. This insures total willingness to control the populations at home. However, the intent would be to

FOR A COPY OF THE NEW
"TROOPERGATE" VIDEO WHICH
EXPOSES THE SLEAZY ESCA-
PADES OF BILL CLINTON WHILE
HE WAS GOVERNOR OF ARKAN-
SAS, SEND \$25.00 TO:

WHISTLEBLOWER
P.O. BOX 650
PALM SPRINGS, CA 92263

have "aliens" provide police action against any given population—i.e., foreign troops patrolling, say, Los Angeles where there is no personal involvement emotionally. It is not a pretty world, readers, and this is what the "schemers" come up with and had carried out by the mind-control programmers.]

Rostow's role in the so-called disarmament program has been crucial. The great result of his and Doctor Wiesner's trip to Moscow in November 1960 was the forwarding of negotiations eventually leading to the Test Ban Treaty of August 1963, and to the later "Nonproliferation Treaty". Much more promptly, the unauthorized Rostow-Wiesner negotiations of 1960 led to the formation in September 1961 of the Arms Control and Disarmament Agency and the adoption by the United States of a program of *General and Complete Disarmament* (State Department Publication 7277), according to which the world would not be disarmed at all, but all weapons suitable for war between nations would be transferred to a United Nations Peace Force, while the nations would retain only such weapons as are suitable for internal-police purposes, including, no doubt, *helicopters; and, of course, rifles, tear-gas grenades, pistols, and some anti-personnel tanks.* Individual citizens, for their part, would not have any weapons at all. That would be the real disarmament. Thus, the so-called disarmament is really a concentration of arms in the hands of the managers of the World Government.

Like so many of his fellow intellectuals, Rostow's great fears seem to center not on what other nations or peoples may do, but on what the United States may do, what the American people may do. We are the main threat to the world order which Doctor Rostow seeks. Again, I accuse of him of no special personal astigmatism here; it is an occupational hazard of the ruling intelligentsia, it is almost a requirement of entrance to the profession, to assume that for Americans to adhere firmly to American interests—at least to American interests as popularly defined—is a danger to world peace. In a way, the exaggerated opposition of American intellectuals to what they might call American chauvinism is itself unconscious chauvinism. For it credits the United States of America with a special importance attributed to no other country.

The Soviet Union is assumed to be also a superpower, in uneasy equilibrium with which, we are expected to maintain a precarious balance of terror through nuclear stalemate. Yet the attitude is implicit in all the literature of the politically sophisticated that the maintenance of this balance is a *peculiarly American responsibility!*

[H: I hope you understand that the really terrorizing fact involved here is that the sophistication has grown and the control overlapping—this book of observations was written a quarter of a century (26 years) ago!]

The Russians, we are informed, may be expected (1) to insist upon rigid respect of the sovereignty of the USSR, and (2) to be capable on provocation of using nuclear weapons first if they go to war. These attitudes are precisely the ones which the United States must NOT assume, we are told, for they are *unreasonable*. At the same time we must not dwell upon their unreasonableness when they are assumed by the Soviet Union! Even in the midst of the theatrical "Cuban Missile Crisis of 1962", which is the nearest that Establish-

ment intellectuals have come to accusations against Moscow. (Adlai Stevenson himself spoke harshly on television to Ambassador Zorin.) Paul Nitze (today's Deputy Secretary of Defense) told reporter Elie Abel:

The greatest danger of war as we saw it then was that we would sink a Russian ship trying to run the blockade. If that happened, it seemed highly doubtful that Khrushchev would hold still without further action. (*The Missile Crisis*, p. 153, Italics added.)

The then Secretary of Defense, Robert McNamara, had a knock-down-and-drag-out encounter about this with the then Chief of Naval Operations, Admiral George W. Anderson. Unfortunately, Admiral Anderson was the first of the two to be dragged out—and sent to Lisbon as Ambassador to Portugal, five years before McNamara moved to the World Bank. The Admiral did not like the sea-hobbles that were put on him when McNamara explained, as related by Abel, that the purpose of the celebrated eyeball-to-eyeball confrontation "was not to shoot Russians but to communicate a political message to Chairman Khrushchev. The President wanted to avoid pushing Khrushchev to extremes. *The blockade must be so conducted as to avoid humiliating the Russians; otherwise Khrushchev might react in a nuclear spasm*" (p. 155, Italics added).

Increasingly for twenty years now, the attitude of the intellectuals has been: *avoid humiliating the Russians*. The United States must avoid even a reasonable act which might provoke the Russians to an unreasonable one. At the same time we must continually approach these unreasonable people. We must tame the bear with kindness. But that is not really very flattering to the Russians, is it? And if it were a fair description of the situation, do bear-tamers really associate with bears on terms of full liberty, equality, and fraternity?

Dr. Rostow assures us that the bear is evolving, and through stages of economic growth will soon be ready for complete fraternity with the human, if somewhat backwoodsish, Uncle Sam. Meanwhile, the important thing is Uncle Sam's own self-control. He must under no circumstances shoot the bear! Well, if the beast starts a direct charge we might shoot him in the shoulder, if we can't sidestep, but do not shoot to kill. Above all, do not use the nuclear rifle—unless the bear uses his first. Does the bear have a nuclear rifle? Oh, yes, of course. He is a very clever and well-trained bear. We trained him!

It seems credible that one of the incidental purposes of the expedition in Vietnam is that it keeps the American military occupied in an operation which cannot actually humiliate the Russians. "As fire drives out fire," so a war in Vietnam—limited in scope, limitless in duration, and of course non-nuclear—may prevent a war with the Soviet Union. Critics of the war in Vietnam say that no American interest is at stake there. That is not the important thing. The important thing to such special intellectuals as Walt Rostow who promote the war in Vietnam may well be that no RUSSIAN interest is at stake there. We Americans have nothing to fear so much as our own military power—goes the theory—and Vietnam is like a roped-off arena where we can go work some of it out of our system

"Within the first decade of the next century, well over 1 billion human beings may be infected with the AIDS virus."

-- Dr. William Haseltine
Chief of the Division of Retrovirology,
Harvard University

AIDS

Secrets, Lies and Myths

EXPOSED!

Jeffrey Shearer

Plus the latest alternative therapies
for AIDS and CANCER

The most complete and shocking record of political,
social, and scientific data on AIDS ever!

FINALLY...

THE ASTONISHING TRUTH,
GATHERED TOGETHER
IN ONE INCREDIBLE BOOK.

The deadly scientific facts about condoms and saliva. The incredible rate of HIV infection among many high school students. The real dangers in: hospitals, medical and dental offices, the blood supply, restaurants, schools, tanning beds, gyms, pools, public restrooms, insects, hospitals, and hotels. How a negative AIDS test can mean nothing...for years.

The truth about the political cover-up and the major AIDS propaganda and disinformation campaign. Incredible evidence about the origins of the AIDS virus, the uses of EMP and biological Warfare technologies, and much, much more.

Plus a separate AIDS Survival Guide to show you exactly how to best protect yourself and your family from the growing AIDS pandemic and its many related diseases. Also, complete safety guidelines and procedures for health professionals.

And a major section on The very latest alternative AIDS and Cancer therapies. Essential information. Massive documentation. 350 pgs. Big 8 1/2 by 11 format.

AIDS Secrets, Lies, and Myths EXPOSED! sells for \$24.95 + \$3.00 shipping and handling.

To order write to:
BioAlert Press Suite 112,
160 N. Fairview Rd.,
Goleta, CA 93117

(The above book is recommended
by Commander Hatonn.)

without endangering the neighbors. Of course, again, Vietnam also brings about a reduction of tension through blood-letting.

In the mind of the special intellectual who is the Special Assistant to the President for National Security Affairs, expedients such as the Vietnamese expedition may serve the cause of the eventual, enforced peace pending such time as we can actually see an "end to nationhood". That phrase of Doctor Rostow's is so famous, or infamous, by now that it seems only fair to give the full context in which he introduced it. It appears in the peroration of his book *The United States in the World Arena*, published in 1960 by Harper, in an "Appendix A," which is a self-contained essay entitled "The National Interest," and is written by Doctor Rostow for the purpose of "permitting the readers to isolate the author's presuppositions for critical examination." Doctor Rostow says that the American people have both military and ideological interests which are subject to various threats, notably the concentration of military power in, or the acceptance of totalitarian ideology by, the nations of "Eurasia", which he defines to include Africa. It is of some interest to note that he seems to classify the Soviet Union as more of a military than an ideological threat; vice versa, one gathers, for Communist China. Noting this "dual character of the national interest", Rostow optimistically, from his point of view, opines that we in the United States can meet "current and foreseeable challenges". But, he says, you don't get something for nothing. We have to give a little. What we have to give is indicated in the following climactic passage, which I have italicized in part to clarify a bit the meaning I think is there:

**THE UNITED STATES AND
THE DECLINE OF NATIONHOOD**

[H: Rostow's heading]

Among those challenges is the problem of using American power and influence to tame military force by effective international accord; for the nature of modern weapons in a context other than American monopoly is a danger to the national interest sufficiently grave to justify acceptance of important constraints on the nation's sovereignty. Put another way, it is a legitimate American national objective to see removed from all nations—including the United States—the right to use substantial military force to pursue their own interests. Since *this residual right is the root of national sovereignty* and the basis for the existence of an international arena of power, it is, therefore, **AN AMERICAN INTEREST TO SEE AN END TO NATIONHOOD** as it has been historically defined.

[H: YOURS!]

The pace at which means of communication are now under development argues, further, that the present nations of the globe will move into relations of increasing intimacy and interaction.

Between them, the urgent imperative to tame military force and the need to deal with peoples everywhere on the basis of an accelerating proximity argue strongly for movement in the direction of federalized world organization under effective international law. And, should effective control of military power be achieved, **it might prove convenient and rational to pass other functions upward from unilateral de-**

termination to an organized arena of international politics.

It is not easy or particularly useful to peer far beyond the time when this great human watershed is attained (p. 549, Italics added).

These are the words of one of the most influential Schemers in the government—in the Establishment. Doctor Rostow does not write to the laity, does not write to make the best-seller list, does not write, actually, to be read. **He writes to influence the men of power within the Establishment.** What he writes could be said far more briefly and appropriately in an interoffice memorandum. It could be said orally over coffee. And I am sure it has been said in memoranda and over coffee. The memoranda and the talk have undoubtedly had far more immediate influence than the books, which few people read. But decision-makers in our country do read the memoranda and listen to the talk **because Rostow has written a book explaining how the stages of growth work, or a book explaining what is the true interest of the United States in the world arena.**

Notice that Rostow says we must use "American power" which would include American military power "to tame military force" which would include American military force! To point out that this means logically using *American military force, or power, against itself is not logic-chopping. That is exactly what Rostow and innumerable fellow "Liberals" want to do.* It is exactly what McNamara did with great effect as Secretary of Defense. The excuse for this gradual national suicide is that "modern weapons" are "a danger to the national interest", that is, the American national

interest. Other Liberals than Doctor Rostow have said more explicitly the same thing, which is that America is in danger from America's nuclear weapons. And that is incontrovertible, for America's nuclear weapons have not all stayed in America, and it is even doubtful whether all of those in America are under what most Americans would recognize as American control. Nevertheless, it is hard to see how Doctor Rostow's conclusions follow—that national sovereignty should be sacrificed, that we should "see an end of nationhood", and that "control of military power" should be put into the hands of "federalized world organization".

If the United States today is in danger from some quantity of nuclear weapons in possession of foreign powers, chiefly the USSR, powers which are, however, to some extent quite obviously "deterred" by nuclear weapons under American control, why would the United States, **deprived of its nationhood**, not stand in **much greater danger** from a federalized world government? For that world government would possess ALL the nuclear weapons in the world, and would be guided (as Doctor Rostow indicates elsewhere that democratic governments should be) by the formula: **one man, one vote.** Consider that under such a government the United States would have only 6-2/3 per cent of the vote, and you will understand precisely what Doctor Rostow intends.

[END OF QUOTING]

Still think you don't have any problems? Now, 26 years later—CAN you undo it? I honestly don't know if you WILL! So be it. I like to think that THE COMMITTEE simply had no REAL IDEA WHAT IT WAS DOING. We shall see...!

GARDEN OF ATON

By Nora Boyles

GOA \$6.00 237 pages

History lives on in this Treasure Chest of historical jewels and gems which open ones' eyes to how it really was and how so much inter-connects.

Discover the clues to early recognition of the ONE God--Aton--and the verification of His name. Earth histories, legends, languages and artifacts explained, Immanuel/Esu/Issa's name and the name of Gyeorgos Ceres Hatonn and more. Learn about the Twelve Tribes of Israel; history of "key" words; Nostradamus' predictions; the early rise of the Anti-Christ, and many, many more surprises.

Dear Nora,

I have only recently finished reading your "Garden Of Aton" and I want to thank you for all the marvelous research you have done. The confirmations of the PHOENIX JOURNALS, Hatonn, Sananda, et al...are heartening.

I thoroughly enjoyed "Garden of Aton" and want to commend you on such a remarkable job. As an aside, it was your book that finally convinced my friend that perhaps old Hatonn just might be who he says he is, and she is now taking an interest in the PHOENIX JOURNALS.

— G.B., Bradford, PA.

Order by mail or phone: credit card phone orders to 1-800-800-5565 (Mastercard, VISA, Discover); Mail orders to Phoenix Source Distributors, Inc., P.O. Box 27353, Las Vegas, Nevada 89126. Please send \$6.00 plus \$2.50 for shipping & handling; Nevada residents, please add 7% sales tax.

Nevada Corporations

ADVANTAGES AND USES OF A CORPORATION

LIABILITY PROTECTION: Corporations as business structures provide liability protection to everyone involved with their operation. From the investor or stockholder to the officers, corporate liability stops with the Corporation. Any activity that a Corporation gets into that is not fraudulent in nature will not adversely affect the personal life of any of a Corporation's participants.

Unlike a sole proprietorship or even a partnership, a Corporation can accumulate debt without ever making its officers, directors or stockholders responsible for the repayment of that debt. If a Corporation gets itself into a law suit, the outcome of that lawsuit can affect the Corporation directly, but it will never be the responsibility of its participants.

Corporations are used in the business world today primarily for liability protection. Corporations came into existence to limit the direct responsibility of all of their participants from the responsibility of the faults or debts of a Corporation. An investor can invest money into a Corporation and that investor's potential loss is limited only to the amount of money invested and no more.

Because of the obvious advantages to limiting the amount of personal liability that one takes on by operating through a Corporation, many strategies have been developed to protect the assets of businesses with potential law suit risk. In addition, other strategies have been developed to protect the assets of individuals due to our crazy and litigious society.

TAX SAVINGS: The myriad of tax benefits that can be achieved by utilizing a Corporation outweigh any other business structure. Many of the tax benefits available to a Corporation can greatly benefit corporate owners. Under President Clinton's 1994 personal tax increases, Corporations have a lower federal tax rate at all levels of income compared to individual rates. There has never been a better time to own a Corporation!

Nevada's popularity is based on the fact that the State does not tax its Corporations. Unlike most states in this country, Nevada has taken a "pro-business" stance. They realize that taxing business is the wrong approach to a healthy state economy.

RAISING CAPITAL: For the individual looking to raise capital for a business or project, the corporate structure is superior. Corporations allow investors an opportunity to participate in the profitability and growth of a business without having to participate in the day-to-day dealings. Through the sale of stock to investors, a Corporation is able to raise capital at all phases of its life cycle. This process can be kept simple by limiting the number of investors involved. However, if a Corporation is planning to raise large amounts of capital and solicit many potential investors, the rules and regulations can become quite stringent.

These are the primary reasons that many

individuals and businesses decide to incorporate. There are also many secondary reasons that just may make all the difference for you. Some of those reasons include the following:

- Control and management of a Corporation is very structured and clearly understood.

- Losses by smaller Corporations can be deducted personally.

- Real Estate can be controlled within a Corporation for the ultimate in asset protection.

- Corporations never die. They have an infinite life.

- A Corporation can provide you with free Health Care.

- Many of your personal expenses can be paid by a Corporation: car, education, legal fees, accounting fees, insurance, moving expenses, seminars, books, meals, entertainment, travel, computers, office equipment and much more.

- Ownership can be easily transferred between generations; without probate, taxes, etc.

•Corporate Pension Plans can allow you to put a lot of tax deferred money away for retirement.

The list goes on and on!

For a free information pack about the benefits of Nevada Corporate Headquarters, Inc., call 1-800-398-1077 or write to P.O. Box 27740, Las Vegas, NV 89126.

ORDER YOUR CORPORATION MANUAL TODAY! Send \$32.95 to Nevada Corporate Headquarters, Inc., P.O. Box 27740, Las Vegas, NV 89126 or order by phone at 1-800-398-1077.

MORE READING

FOR GENERAL BACKGROUND INFORMATION ABOUT PRIVACY, THE VALUE OF NEVADA CORPORATIONS, THE MASSIVE DECEPTION OF THE FEDERAL RESERVE AND ITS IRS EXTORTION RACKET, AND THE GENERAL TRUTH BEHIND OUR MODERN ECONOMIC MALAISE, SEE THE PHOENIX JOURNALS: (#4) SPIRAL TO ECONOMIC DISASTER, (#10) PRIVACY IN A FISHBOWL, (#16) YOU CAN SLAY THE DRAGON, AND (#17) THE NAKED PHOENIX. See Back Page for ordering information.

Quick
Name the
only state
where
corporate
ownership is
anonymous,
there is no
state tax, and
confidential
tax forms
are not
exchanged
with the IRS.

It's Tax Free Nevada. (The last of the "safe havens")

If you're looking for the benefits that Incorporating has to offer, such as limiting your personal liability, increasing tax-free benefits, and raising capital through the sale of stock - taking just 5 minutes of your time to explore the benefits of forming a Nevada Corporation could save you and your company thousands of dollars.

No State Boundaries.

No matter which state you live in, you can still utilize and reap all of the benefits of a Nevada corporation. And you don't even have to visit Nevada to operate a Nevada corporation.

No State Taxes.

You can save a bundle on taxes. The state of Nevada does not tax the income of its corporations or its state's citizens.

Complete Privacy.

Nevada statutes have developed a corporate structure that allows owners and investors of Nevada corporations to remain completely private. Plus, Nevada is the only state that does not have an automatic exchange of tax forms with the Federal Government.

Asset Protection.

Protect your assets from potential lawsuits and threats. Nevada, the "safe haven" state has a corporate structure designed for privacy and obscurity.

Low Cost.

Nevada is one of the lowest costing states to incorporate in. Your annual fees to have the privilege of owning a Nevada corporation are only \$85 a year.

It's easy to start.

Simply give us a call and one of our knowledgeable corporate consultants will assist you in answering any questions that you may have.

For more information contact:
Nevada Corporate
Headquarters Inc.



P.O. Box 27740
Las Vegas, NV 89126
Telephone: 800-398-1077
OR: 702-896-7001

Alliance For America

Editor's note: The following arrived in the CONTACT office via fax on July 20, 1994. We have decided to run it; even though the plea may be past being timely the information for documenting history is still very much needed by all of us. Thank you, again, to our American Patriot Fax Nextwork Friends.

Alliance For America
P.O. Box 449
Caroga Lake, NY 12032

Ph(518)835-6702 Fax (518)835-2527

July 14, 1994

IMMEDIATE ATTENTION NEEDED!!!

Unless there is a mass outcry immediately, within days the Senate will ratify the Convention on Biological Diversity, one of the most dangerous pieces of international legislation ever enacted. Also known as the "Biodiversity Treaty", it will mandate nations to adopt a new philosophy of government with a vast system of laws and regulations based on the doctrine of "sustainable use".

If the Senate ratifies this treaty, the national sovereignty of the United States will be at stake. This treaty must be stopped. Call or write to your Senators immediately.

The Biodiversity Treaty violates the Constitution in the following ways:

1) The Senate will not ratify a finished document, but merely a statement of principles. The actual protocols (mandates) of the treaty will be decided at a United Nations "Conference of the Parties", that will take place in November of this year. By ratifying the treaty the Senate will be handing a blank check to the extremist faction of the international environmental movement. The United States, its Congress and the American People will be legally bound to implement any protocols adopted by these non-elected agencies.

A supranational body has already been created to enforce the mandates of the convention. The three environmental organizations which will be drafting the protocols are the World Resources Institute, the World Wildlife Fund, and the International Union for the Conservation of Nature.

2) The new doctrine of "sustainable use" demands that human existence shall have no more judicial rights than any lesser species. Most present day human activities, including farming, logging, fishing, and mining, violate the tenets of "sustainable use". The use of fertilizers, pesticides and insecticides, for example, is an "unsustainable use" of the land, according to the fanatics that wrote the treaty. Present day consumption patterns and outdoor recreational activities are also considered "unsustainable". Present day human

population levels are also "unsustainable". The productive development of private property is an obstacle to "sustainable use". They mean to control every aspect of human life.

This will be accomplished through the establishment of international laws which will dictate economic stagnation and population reduction. The U.S. would revert, under this treaty, to a colonial form of government with less freedom than we had before the American Revolution.

3) The treaty violates the Constitution's separation of Church and State. Biodiversity is not a scientific theory, it is a religious dogma which espouses a belief in "biocentrism," the view that all species have "equal rights" and that man has no rights higher than those of animals or insects. It will force Americans to worship nature.

Many of the principles of the treaty have already been adopted by Federal Agencies under the guise of "Ecosystem Management". A Department of the Interior Internal working document mandates Federal Agencies to manage human beings "as a biological resource".

If you don't want these environmental extremists to seize further control of our Government, you must make your voice heard. Call your Senators immediately and demand that they vote against the ratification of this treaty. Demand a full investigation of the Ecosystem Management revolution which is already implementing these doctrines within Federal agencies.

Call the U.S. Capitol Switchboard 202-224-3121 and ask for your Senator.

Call now, there is no time to lose.

Pot-Stirring On O.J. Race Riots

7/19/94 #1 HATONN

RACE RIOTS, ETC.
(MISHPUCKA)

This is a valid term and you had better get accustomed to using it, seeing it and hearing it [*Mishpucka means the Zionist "Jewish" mafia*]. It is exactly what you are being set up for having on a massive and national scale. The encompassing things will be such as Haiti, O.J. Simpson, the new "Jackson" (Rev.) upheavals and even the [*Jocelyn*] "Elders" matter with the son who was arrested for "drugs" and thus and so.

The Simpson matter is taking front seat in publicity but what is happening right now is atrocious. A police officer is being set up as a cause for racial clashes in that case. You can't help but follow the case because a necessary move on the part of the media to precipitate desired results is to offer inflammatory information on cue to precipitate desired actions from otherwise uncaring citizens. At this point it will be basically a Black vs. White issue and Black vs. police issue. The fact that all of

O.J.'s attorneys at this time are JEWISH will prove to be another focus as the trial continues. It looks like the Jews are on the side of the blacks—but this will prove to be OTHERWISE and there will then become a three-way uprising. Out of this will be possible the passage of "hate-crime" laws because of the so-called "anti-Semitic" elements involved.

It is a BIG plan, readers, and behind the splashing and sloshing of pebbles on Jupiter—you have a major world series of events coming down. Don't blink both eyes at once or you will get "behind" and "blind-sided" before you realize it.

Let me assure you that O.J.'s lawyers have had this information on the officer, Furhman, since upstart so you can be sure there is positive reasoning behind the maneuver now under way.

These riots will not be sloppy half-baked flings as prior skirmishes have been, my friends—this will be "big time", "worldcup" stuff of which WARS are made.

What will your "militia" do then? Indeed, you had better be considering these things—because the "Crips" and the "Bloods" are now WELL-TRAINED KILLERS. No more are they just children without a cause—THEY HAVE BEEN TRAINED INTO A "CAUSE"!

HAGAR



©1994 by King Features Syndicate, Inc. Word rights reserved.

Truth Reveals Itself Even From Garbage

7/18/94 #1 HATONN

LET'S HAVE SOME INSIGHT
AND SOME FUN

"DUGGAH" AND "HATONN"

"Who in the world are Duggah and Hatonn?" you, I hope, are asking. I don't know either but I shall point out a couple of things to watch for along the lines of the next writing—especially that which is between the lines for it will show up right up front that neither the person, nor the energy claimed, has studied very much of any of "our" information—good or bad. Remember, George Green told the world (everybody in earshot or on radio receiving waves, etc.), that "Hatonn moved with him and Desirée to Nevada" and he, too, was receiving.

Now, comes this writing from "Duggah" as PROOF of Green's statements that the one in Tehachapi is some kind of nerdnick receiving from an unknown energy form. I am going to point out to YOU what it is you do when you hold such documents. Greens are now sending this message from someone called Hatonn to someone called Duggah. Truth and perception in truth are the SAME from any speaker or receiver—so, I want you to measure that which is offered against that which is documented and KNOWN. And, why would this unknown speaker reserve the information FOR THE ONES WHO ARE IN THE BATTLE?

How do I know that this "may" be true? Because the writing was sent to here from one in Florida who has been badgered constantly to join Green in the pull-down of the Institute—and who, by the way, would suffer great damage from such doings.

I ask that you study the questions assumed asked and the answers given. You do not need psychics telling you what is what—YOU ONLY NEED TO KNOW THE GUIDELINES OF TRUTH IN INQUIRY AND TRUTH IN INFORMATION OFFERED—IN OTHER WORDS, FOR WHAT ARE YOU SEARCHING? ARE YOU LOOKING FOR PSYCHIC RECEIVERS TO HOLD YOUR HAND AND GODS AND HOSTS TO PAT YOUR PO-PO—OR DO YOU WANT TRUTH ABOUT YOUR CIRCUMSTANCE AND "KNOWING" ABOUT YOUR JOURNEY?

Is THIS "Duggah" good or bad, valid or invalid? Who cares?? IF TRUTH ABOUT THAT WHICH MAKES YOUR JOURNEY INSIGHTFUL COMES FROM SATAN HIMSELF, YOU HAVE A MASTER TEACHER. IT IS YOU WHO MUST DISCERN—NOT A "DUGGAH", "DORIS", J.Z. or Dinky Pool!

How can you tell if "Hatonn" is ME? Well, that is easy for "me"—but perhaps not for YOU. The reason? Because I am here and I have a style of writing and this does NOT match either my style OR THAT WHICH I KNOW. How can I tell "right off"? Because the "answer" is not in response to THE QUESTION

and the answer given refers to ME when the "authors" in point—ARE NOT ME, never were and are part of the confrontation in the first place. THESE are the points you look for, glean the truth and discard that which is false. So, let us give the writing a go-over and see what is there. Why do I take time to do this? Because I am asked by S.Y. to do so and comment and she is dear to me.

As is typical of such types of writings and writers there is no information as to date of writing, time of writing, author, receiver (other than Duggah), etc. This is fine for the ones who are familiar with all this information but to comment on something which may have come yesterday or ten years ago is of importance. So, we will have to do some "assuming" which is usually a bad idea. However, since it does serve George Green so nicely—it must be recently written for it refers to the problems present in encounter as well as is being used to foster support for Green's position as regards US&P. It does not, however, SEEM TO REFER TO THE GOLD GEORGE THIEVED OR OTHER SMALL INSTANCES SUCH AS THAT! Therefore, you can deduce up front that the response does not fit the question in point nor bring in the whole of the information of FACTS relative to the represented response, if it be valid. Indeed I WILL nit-pick along the way because, until you can judge such writings and discern purpose of such receivers—you CANNOT realize that which is valid from that which is not.

[QUOTING:]

I am Hatonn. I come to you in Light and in service to the One who is All. Thank you, Duggah, for allowing me this opportunity to share with you. I am available to all who inquire of me for the sharing of information and awareness.

I am asked about the validity of the information coming from one who claims to receive from me in Tehachapi, California. Yes, the contact was initially a valid one. However, when the receiver first opened up to receive my energy, many psychological issues arose that she needed to confront.

[H: Alright, the question is: "validity of the information". WHAT INFORMATION—there are well over 25,000 pages in journals and another 20,000 pages in CONTACT (separate) and thousands of pages written before journals—by hand, along with probably 3-4 thousand HOURS of taped material. WHAT INFORMATION IS REFERRED TO? ALL OF THIS HAS BEEN GIVEN BY "US" (NOT JUST ME) THROUGH THIS RESOURCE IN SOME SIX YEARS. WHAT INFORMATION DOES THIS ONE ATTACK? HOLD ON, IT WILL BECOME QUITE EVIDENT, VERY QUICKLY. By the way, this receiver and that receiver and whichever receiver is VALID—EVERY TIME! So the point is never about the

receiver—it is only about information and speaker. ALWAYS!]

First among these was the Ego. The Ego believed this experience to be an exciting one, but also one of which she was not worthy. If she had been strong enough in her own being at that time, she would not have had to look to the outside for validation and confirmation.

[H: Oh? Strong? Does this speaker and receiver question STRENGTH? SIX YEARS OF HELL AND THE TOTAL STRIPPING OF EVERYTHING AND STILL WE CONTINUE THIS SPITTING IN THE WIND—AND WE SPEAK OF STRENGTH AND EGO? This foolish observation, without knowledge or wisdom, embarrasses me and might well embarrass the entities in point. It reminds me of one who came to visit this place some six years ago and said: "I, by God, am going to do God's work but, by God, I am going to do it MY WAY!" Is "this" the kind of EGO "strength" to which this writing might refer?]

From her belief of unworthiness, a separation was created. My energy cannot be fully received on your level unless the receiver feels worthy of it. [H: Well, I guess this one in point feels pretty "worthy"—but I guess I don't so she/he better stay with what is there because in the end he/she is going to be left flat abandoned! I shall not stoop to further games on semantics—"he" has been accepted in the English language to suit either gender in writing—therefore I shall refer to Duggah as "he" with no offense intended to that "ego" involved.]

In the gap formed by the separation [H: Separation? Separation from what? By the way, uneducated ones—no physical expression can FULLY RECEIVE ON YOUR LEVEL any total energy form of etheric beings from Creator dimensions. If you THINK otherwise, that is part of your erroneous understandings. That does not mean you are lesser—only that you are not grown in understanding and insight in your consciousness. I would NEVER ask any "secretary" to bear responsibility for FULLY RECEIVING MY ENERGY—what kind of stupidity would THAT represent? If I be the "teacher" would I do that to my "student"?] a psychological construct formed that normally could serve as an intermediary for contact between myself and others from your dimension preserving the integrity of each existence and serving further as an energy transformer. [H: Say what? Psychological construct? What in the world is that? Serve as an intermediary? Is it not your reliance on so-called intermediaries that has gotten you into this lack of responsibility in the first place? Why would Dharma need an intermediary? She is the first one to resign her job every day of her life—because it ain't so great, good friends! Now this "party" tells us that an intermediary between me and her "warped" lack of normalcy would serve as a transformer of some kind. Yes, I think so—transformers transform—from one thing TO ANOTHER and that is EXACTLY WHAT HAPPENS ALL THE TIME—TRUTH IS OFFERED AND IT IS TRANSFORMED!!—TO SUIT THE NEEDS OF MY ADVERSARY!] If the receiver is clear within his or her being they would normally pull in my energy behind, so to speak, that of the intermediary. [H: Boy, this one "Duggah", "Hatonn", and Green would really like that wouldn't they?? I think it becomes obvious WHY GREEN didn't send this directly to ME or to Dharma! You see,

you can always further JUDGE situations by how they are handled—don't take it to source but anonymously scatter the gossip. You have to understand that the information arrived to S.Y. without name but FROM BOZEMAN, MT—AND ALL OTHER SCRIBBLINGS AND DATA, INCLUDING THE ENVELOPE RETURNS, SHOWED IT TO BE FROM AMERICA WEST SOMETHING OR OTHER. THE ADVERSARY ALWAYS WORKS WITHOUT IDENTIFICATION! OR IN THE LIE AND SECRECY OF HOPED-FOR SECURITY OF DARKNESS. The intended meaning in this statement above is that the true entity would have transformation of information through that intermediary! I THINK NOT, READERS—YOU DON'T NEED AN INTERMEDIARY—YOU ONLY KEEP THEM AROUND TO ABSOLVE YOU OF YOUR OWN RESPONSIBILITY—i.e., "The Priest told me...!" The intermediary is literally a combination of our energies and in this case has taken on a "life" of its own.

[H: Perhaps I misunderstand? Perhaps he is saying Dharma has created an intermediary? That couldn't be because he also states that there is "separation" and information is becoming somehow "transformed". But we will see later that the only subject in point as to information regards Mr. Green and WHY Dharma has a lawsuit from US&P. The fact that Mr. Green was FIRST listed, and still is, on the suit—seems to be overlooked by both this energy and receiver. Should a "speaker" be so ill informed while throwing boulders at another?]

Unfortunately, the intermediary can grow and become "addicted" to physicality. It will tend to form a secondary personality that becomes stronger and stronger until I am unable to be reached unless there is a window of some sort. [H: To you who know Dharma, this needs no comment!]

In essence, the intermediary is like a child and truly is the product of myself and the receiver. [H: This cannot be truth—for I am NOT a child—in singular energy OR combined! Dharma may be that which she chooses—in her off-duty time.] In this case, it appears to be me [H: Doesn't appear to me to be "me".]; in other cases, it can appear to be either and/or both myself and the receiver. [H: Does this mean there is also total stupid chaos on the higher-teacher levels of perception? Appear? Other cases? TRUTH IS CONSISTENT AND INFINITE—TRUTH STANDS AND THE FALSE WILL GIVE AWAY ITS FALSENESS—IT NEEDS NO ARGUMENT NOR DEBATE. TO MAKE ACCUSATIONS AND ESPECIALLY PERCEPTIVE ACCUSATIONS IN ABSENCE OF ALL FACTS SHOWS THAT STUPIDITY QUITE CLEARLY. DO YOU WANT YOUR TEACHERS AND LEADERS TO BE STUPID, ERRATIC, CHANGING IN THE WIND AND MORALLY CORRUPT? Do you see that we are already a long way off the subject of the question in point: Is INFORMATION GIVEN through Dharma VALID? NOW, let me present you with another thought: "If Dharma's information was invalid, which it is not, regarding Green, US&P, etc., why would the proof in documentation PROVE that Dharma is not the one who is invalid?" Further, will Dharma's opinion of one George Green, US&P or Hatonn—make any difference in the TRUTH OF INFORMATION WHICH FLOWS FROM HERE AS REGARDS THE MISSION TO YOUR PLACE AND SPECIES?

For instance, if I tell you that the circuits to one of the largest metals dealers in the world were locked on Friday and today—is that an opinion or a fact? Check it and see—that is

exactly what happened on Friday and today. What might that indicate? Disaster, frozen prices, change in currency evaluation, what, what, what? Well, there are lots of possibilities and if you are a regular reader—YOU WILL KNOW WHAT THEY ARE! THIS HAS NOTHING TO DO WITH DHARMA, DORIS, DUGGAH, GREEN OR PURPLE PEOPLE EATERS!]

This ultimately created a distortion in the reception and has limited the knowledge received to that obtained by the receiver from other sources or from the initial contact with myself. [H: Upon what basis of KNOWLEDGE does this energy or receiver DARE to foundation such garbage? Reread the above. How would either the energy OR the receiver above have any notion as to what happened in the mind of one, Dharma/Doris and me—another energy? From what source of educated, scientific realization COULD such a party, who knows not either entity—base such authoritative information statements—not speculate or "may be"—but "ultimately created..."?]

That is why the Tehachapi receiver has been faced with a lawsuit from an entity known as the University of Science and Philosophy. [H: NO, and it is certainly beyond STUPID to infer such a thing—her energy intermediary or transformer or fat little pickle pluckers are NOT responsible for the problems with US&P—very earthbound physically produced STUFF is the reason—and validity of information OR psychic anything has NOTHING TO DO WITH IT!] She was given the choice at the time to recognize that her contact was with the intermediary and not with me. Instead of facing that responsibility, she chose to blame the publisher of her material.

[H: If you readers don't see this one—then blindness is a hopeless handicap ye shall have to share. Firstly, the "authors" of the volumes of magazines in dispute WERE NOT "ME" (TRY "Russell" or "Germain" or...). Secondly, WHO IS RESPONSIBLE FOR PUBLICATIONS AS A PUBLISHER? Thirdly, DHARMA, DORIS OR ANYONE AROUND HER HAS NEVER RECEIVED ANYTHING FOR THE PUBLICATIONS OF THAT PUBLISHER. Fourthly: The publisher got permits and information from OTHER authors of material—why suddenly did he fail to cover US&P? He claimed to be a good buddy of the President of that entity and SAID IT WAS OK TO USE THE INFORMATION. This could go on and on—but still does not take up the theft of the gold by Greens nor the other criminal activities worked out with such as Anderson, et al., OR address the real issues in point of his AGREEMENTS with US&P SEPARATE AND APART from the other "minor" named defendants in the original suit. It does not address how he made claims all about the globe that he had the books released TO HIM from the court and even got the poor attorney into trouble. It doesn't cover the other 95 volumes of writings—nor the ones through the first 50-some-odd in which HE SHOWS AMERICA WEST COPYRIGHTS!

Do these documentations abounding—REALLY indicate that Doris has no possible reason to suspect that perhaps Mr. and Mrs. Green might just have done something rather unsuitable? Dharma WRITES and sometimes SPEAKS—FOR ME AND SOME OF MY COMPATRIOTS—so does Mrs. Green (or claims to do so) and so did Mr. Green indicate nationally that "Hatonn speaks to and through me and came with Desirée and me to Nevada!"

The writings here are turned into published form ONLY as magazine periodicals and newspaper—validly licensed and operating under the rules and regulations of news reporting—which

means that no KNOWN LIES ARE PUBLISHED AS TRUTH! It is mandatory, further, to NOT use the hypothetical blitherings of some bodiless, vapor-trailed entity form—when truth of prior publication and fact is present! You want NEW REVELATION? THEN GO SOMEWHERE ELSE—THAT IS NOT MY JOB NOR INTENT! I personally hope that Mr. Green sends this writing of Duggah's off to everyone on every mailing list in the world mailing system—it can only HELP OUR CAUSE OF TRUTH!]

I have the utmost compassion for the receiver, but at this point, I can no longer allow her to state truly that the material she is receiving is from me. [H: Which receiver? No longer allow WHO to state truly that the material she is receiving is from me. Most of the information printed here with Dharma, is gathered right off your place—I just pick it out and comment! I guess "I" don't share the totally "unconditional compassion" of that other entity—for I will allow her and it, or him and it, to write anything they wish—for they ONLY MAKE MY POINT! I only suggest you get background on all information and THEN make decisions of YOUR OWN. This is obviously NOT worthy of further time wasted.]

I hope this answers your inquiry satisfactorily. I am Hatonn. I take your leave in the Love and Light of Truth. [H: Well the old boy could have saved a bit of face by taking "his own leave" in love and light of truth—but "take your leave"? Ah it is always the little things that will spring the trap, readers!]

[END OF QUOTING]

Yes, I could go on about this into volumes—but you are big kids now and must come into your own adult discernment. We have given you ways of measuring all things against that which God Creator offers as guidelines—but YOU have to shoulder your responsibility of all background work and thorough investigation. Anyone basing anything on one page of written answer to such narrow and foolish inquiry which has no basis, no names, no dates—nothing—is foolish at best.

I am grateful for the opportunity to respond to your inquiries—you who have received the paper in discussion. I have no further comments if you will allow me to go back to our important work.

There are so many things taking place right now as to boggle the system and they must be attended, watched, and more background on players and the game, poured in.

Now what do you want in my comments about Green? His actions, too, speak louder than ANYTHING I could possibly say. John Schroepfer and others who have "blown the whistle" on Green [see p. 44 of the 7/12/94 issue of CONTACT, "One Man's Journey To Freedom—Greedy Conspiracy Exposed"; p. 15 & 59 of the 7/19/94 issue, "Update on Friend John Schroepfer" and "Notes Of Thanks"] and "the Plan" to bury John—speak louder than any words could ever say on the matter of integrity and TRUTH! If people will do THIS ATROCIOUS AND BITTER ACTION against a literal brother—what think you they would do to retain gold and secrecy of their actions? Yes, it IS bad—but it has been agonizing and HELL for John Schroepfer, locked away in WORSE THAN A PRISON—to preserve George's and Eleanor's and associates' assets and plans.

I think you can stop worrying about this speaker or that speaker or this entity or that entity—those in point will give you the answer in EVERY INSTANCE as TRUTH "OUTS"! AND, TRUTH SHALL ULTIMATELY ALWAYS "OUT"!

Can we please turn back to our work in progress? Thank you.

CONTACT Must Walk A Careful Line

7/19/94 #1 HATONN

This little message is probably worthy of hot line as we want everyone to PAY ATTENTION! Thank you.

WILLIAM DUDLEY PELLEY

I am so often asked about such as the Pelley Papers and more often, the *GOLDEN SCRIPTS*. How valid is the information? I think I don't need to respond to THAT particular question other than by offering this presentment:

[QUOTING:]

IN THE DISTRICT COURT OF THE UNITED STATES FOR THE SOUTHERN DISTRICT OF INDIANA INDIANAPOLIS DIVISION May Term, 1942

UNITED STATES OF AMERICA

vs.

William Dudley Pelley,
Lawrence A. Brown,
Cr.
Agnes Marian Henderson,
Fellowship Press, Inc.

No. 7391

WILL BE STOPPED. An armed militia IS WITHIN THE LAWS OF YOUR CONSTITUTION AS A NATION. DO WITH THAT WHAT YOU WILL BUT DO NOT GO FORTH AND SAY THAT ANY AT CONTACT ADVOCATE WAR OR ARMED REBELLION.

If articles or writings are printed in the paper regarding such activities, it is for information only and will be presented with disclaimer EVERY TIME. There ARE ALWAYS LEGAL ways to change a system if you act in reasonable timeliness. Locking the barn door and burning down the barn AFTER the horses have been taken—is of no value whatsoever and if it is, in fact, a confiscated barn—you will be charged and convicted of treason and unlawful behavior. If a barn-tender (guard) is injured or slain—YOU WILL BE CHARGED, CONVICTED AND PROBABLY EXECUTED FOR MURDER!

I do want to offer you the EXACT indictment as it happened because you must see how dangerous it is to walk on the brink of such disaster. LaRouche is another prime example of unfair indictments and convictions—along with his people. Remember, one

of LaRouche's secretaries got something like 68 years in prison for simply being there. JUSTICE is not in point here. THERE IS NO JUSTICE, so stop dwelling and time-wasting suggesting that this or that is not just—OF COURSE IT IS NOT JUST! YOU WILL WORK WITH "LAW" AND WITHIN "LAWS" OR YOU WILL BE INCARCERATED OR SHOT, OR BOTH!

EXAMPLE

There is now afoot an attempt to "get the CONTACT" because of the letter of Ronn Jackson to Linda Thompson regarding "insurrection" [which appeared on p. 2 in our 7/5/94 issue]. No thank you, good friends. CONTACT, perhaps unwisely, printed Mr. Jackson's letter—along with an editorial disclaiming any association with anarchy or sedition. A lot of time and attention has been given by this paper and MYSELF to the freedom of Mr. Jackson. This is NOT for the purpose of shutting down the paper, arresting my writer, or for gathering a glob of militiamen—armed or unarmed. It was printed because of FREEDOM OF THE PRESS in which all voices of the people can be heard and, in result, wise counters and measures can be thought out and LAWS APPLIED AS RELATE TO FREEDOM THROUGH CONSTITUTION! If you want a warrior leader—it will not be me. I am a different KIND OF WARRIOR—I NEED NO GUNS OR SWORDS—SAVE THE SWORD OF TRUTH THROUGH CREATOR/CREATION. Neither do YOU, so the only difference is that I KNOW and YOU APPARENTLY DO NOT YET KNOW!

Jupiter & Bogus Boulders

7/19/94 #2 HATONN

JUPITER AND BOGUS BOULDERS

[END OF QUOTING]

I will not offer the case in point, here, at this time. Suffice it to say that there was a Federal Grand Jury convened and an indictment for SEDITION brought against the above-named parties and a publication called *The Galilean Magazine*.

To you who continue to prod and cause CONTACT to act more biased than an ordinary proper newspaper—you are asking that the same be brought forth against the very resource of information.

If, in fact, the CONTACT ever digresses or, as some of you prefer, progresses, into seditious acts or insurrection printings, I will be considered withdrawn from any association with same. In that instance, I can promise you that there will be no "Contact" BEYOND THAT DATE.

A Newspaper and Current Information Magazines have responsibility to print what is brought forth, with credits to the authors of said information and if hear-say is present in the information IT WILL BE SO STATED!

We have had ones who tout that the CONTACT backs THEM in their uprisings and urgings to do this or that. NO, we urge you to get informed, voice stance and ACT ONLY WITHIN RECOGNIZED LAWS! To gather guns and go march on something is not acceptable to me OR TO YOUR VERY ENEMY AND YOU

You continually want to know that which is elusive to you—not that you will prepare and do something—but only from curiosity do you seek—and/or—to know FIRST and show all sorts of wisdom and insider knowing. I won't do your homework but I will tell you this much, you had better find out what ones such as [Zecharia] Sitchin have written and along with that, what Jupiter is all about! Those are not cattail rocks hitting Jupiter and I can promise you—as a species civilization on Planet Earth—that if you fail to bring order and balance again to your globe—there will be a RERUN OF JUPITER. THE DIFFERENCE WILL BE THAT THE FIRST "BIG ONE" WILL TAKE OUT THE EARTH POPULATIONS.

What is being witnessed and VERIFIED BY CURIOUS SCIENTISTS AND READINGS OF THESE JUPITER BLASTS IS THAT IT CANNOT BE COMET FRAGMENTS! Watch those next few "bigger" ones they claim to be expecting! If the atmosphere is not turned into a burning gasball, basically representing a new "sun" spot it will be interesting. Jupiter has WATER—why then, are there not vapor clouds? I suggest all of you earthbound energies take note—if something is not changed—YOU ARE NEXT! I DON'T CARE WHAT YOU CHOOSE TO CALL IT.

Pontius' Puddle



© Kaufman

Buried In Questions Beyond Endurance

7/20/94 #1 HATONN

NOT THE LOCAL GURU OR
MEDICINE MAN
PLEASE CHECK IT OUT

Dear friends, I have to take up another subject before we can get at our work today. No, I am not angry and I do wish I had a hookup to every "personal" ear—but I do not—THROUGH DHARMA.

We sit to our work and she is devastated—absolutely swamped in questions, inquiries about this or that—and "ask Hatonn..." NO! Her job is to write for me for 6-1/2 BILLION people and the evolution of the greatest cycle uniting of a planet. She types hours and hours EVERY DAY and has meetings "for me" in between. She has no life at all to call her own, no property and no corner on answers to her own pleading inquiries even as to how much longer can she continue this pace and output.

There are some 150 letters, sitting to her right, directed TO HATONN awaiting responses, a paper to write, a journal to finish, a meeting scheduled and a Court appearance tomorrow morning.

The letters which have her so upset in postponement and the inquiries in behalf of, and personal pleadings for direction and purpose are too much, readers. I can accept them all—SHE CAN NOT! What is painful, however, are the continual proddings and disappointments of: "I'm not getting any feedback from all my inquiries..." How do you expect the information to flow in response to your inquiries? Ah Ha! I thought so—THROUGH HER FINGERS??? It cannot longer be that way. Dharma is still "...and I'm waiting and seeking for my purpose...surely I'm not to just forever be a secretary!"

I WILL NOT answer questions regarding health and medical treatment—FOR ANYONE ON ANY SUBJECT OF TREATMENT WHICH CAN IN ANY WAY BE CONSTRUED TO BE "PRACTICE OF MEDICINE". I AM NOT IN THE BUSINESS; I AM NOT A GURU OR FAITH HEALER, A REFERENCE BOOK, OR AM I GOING TO TAKE UP A REFERRAL PROGRAM WHEN THERE IS A QUESTION OF TREATMENT OF ANYONE ANYWHERE!

We will offer whatever we have and can share—we CAN DO NO MORE—do you all understand? The hazards of even commenting on "treatments" or possibilities—especially without having more than second-or-third-hand inquiries is ludicrous. If you wish to confer with other holistic or brothers in the same line of healing—please do so—I AM NOT IN THE LOOP PLEASE! This is NOT an offense, please—we are going to follow regulations which honor whatever laws (right or wrong) are thrust upon us at ALL TIMES. YOUR inquiry answered—may well put Dharma into prison!

Neither can I respond to each of our readers with an outlay of YOUR PURPOSE OR NEXT DUTY! I can't, either, set aside EIGHT years of work on a motion picture already in another's charge—to fit a sudden awakening of someone elsewhere who would like to now work on *Sipapu Odyssey*.

I CAN tell some of you who continue to plead and prod for personal direction and input, instructions and placement: This is NOT the answer point—everyone here is buried in work and there are NO FUNDS AVAILABLE to hire help. Volunteers are NOT THE ANSWER for I have yet to have more than a mere few who can ACTUALLY attend themselves without support from other sources. I cannot attend your talents—YOU MUST ATTEND YOUR TALENTS. EXPERTISE COMES ONLY WITH EFFORT TOWARD THAT ACCOMPLISHMENT—IT DOES NOT FALL UPON YOU LIKE RAIN FROM THE HEAVENS!

Would you believe me if I tell you that most of you who inquire about sickness and healing have the answer in your cupboard? But you have to utilize what is available. I have people over and over say "...well no—I don't use it regularly" or, "well, it didn't seem to do much and I used \$25.00 worth of it..." and thus and so. Then you want some OTHER magic. No, THERE IS NO MAGIC HERE! If you are taking your Gaiandriana and other suggested supplements along with cleaning your water with food-grade hydrogen peroxide [see *Next-to-Last pages*] AND if you are having memory loss and other signs of aging, some added B-12 and a B-supplement emphasizing Niacin, then I can only suggest one other thing. If this is accompanied by "arthritis" or "rheumatism" take some added zinc—hopefully balanced with the proper amount of magnesium necessary for utilization. Then, add a tablespoon of CIDER vinegar to a glass of water or Gaialyte three times a day. CarbraGaia would make up that difference but I understand the producer doesn't have any yet. Neither do I know what in the world happened to the cartilage supplement. A whole bunch of innocent sharks are meeting their doom waiting for you to get going, producers! This should have been available months ago. I cannot push harder—for one reason, the products have carried the paper and allowed for remaining in operation. I will ask no more of these people. Distributors of other products and supplements and even to make-up these new products (especially, I should say) REQUIRE FUNDING UP FRONT—A LONG WAY UP FRONT AND IN TOTAL! THERE IS NO SLUSH FUND TO COVER THIS!

As to "cures" for diseases and that which is coming down on you—there are NONE! You can "feel" better and you can help yourselves—BUT THE CURE WILL NOT BE ALLOWED! Does everybody understand me?! I AM NOT HERE AS GOD, I AM HERE IN SERVICE UNTO GOD—AND I REMIND YOU THAT THE ADVERSARY

OF GOD IS GOING TO DEPOPULATE THE PLANET TO SERVE HIS OWN GREEDY, GODLESS NEEDS AND DESIRES. IF YOU DO NOT WISH TO BE IN THE CATEGORY OF ONE AMONG THE NUMBERS—TAKE CARE OF YOURSELF, KEEP YOURSELF WELL AND COME WITHIN THE SHELTER OF GOD'S LAWS AND INSTRUCTIONS. HE WILL NOT SAVE YOU—IF YOU ARE "SAVED" IT WILL BE OF YOUR OWN SOUL EXPRESSION. HE WILL PROVIDE ASSISTANCE AND TOOLS. YOU WILL DO THE REST OR IT WILL NOT BE DONE—AND CERTAINLY NOT BY A SHIP COMMANDER.

Some of you write and pray and give all to me, Hatonn, of self, direction and service. NO, NO, NO!!!! Do not dump your responsibility off onto me for I will not accept it! My purpose, my mission and my Command is in the service of God and unto you I am commissioned to BRING THE WORD. YOU WILL CHOOSE OF YOUR PATHWAY AND YOUR JOB!

MUST STUDY IT ALL

I know that, especially if you have read ALL of the journals and papers, that you are informed. Let's see. Without looking back, name the SIX persons I asked you to look for in the current ongoing writings about the usurpers?? Do I make my point? Dharma had to take this test just now—and even being the WRITER for me—could not name them. How can you expect to serve as my right-hand if you cannot even remember the names of players—and these are but small-fry players. I'm sorry—GRACE may shower upon you in an instant in glory—training and learning, education in knowledge DOES NOT! The heart and soul may find a burst of insight and understanding—but the physical tasks at hand must be attended by the knowledgeable in THAT task. To announce you want to be a "cameraman" in the movie or direct the show—when you don't even know the component parts of A CAMERA—is ludicrous. If you REALLY want to be a cameraman—GO LEARN EVERYTHING THERE IS TO KNOW ABOUT IT AND BE BETTER THAN EVERYONE ELSE. WALLY GENTLEMAN HEADS OUR MOTION PICTURE PROGRAM BECAUSE HE IS THE BEST AND UNDERSTANDS HIS TASK—IF NOT EVERYTHING (OR EVEN ANYTHING) ABOUT THE REST OF THE JOBS.

Right now, because some ones have been involved in various tasks, consider that they are now IN CHARGE, either of funds, business acquisitions, etc. NO—IFYOU THINK I WOULD HAND OFF RESPONSIBILITY TO ONES WHO CAN'T FIND THEIR WAY OUT OF A LOCKED CLOSET—DO YOU ACTUALLY THINK I WOULD TURN OVER THE EVOLVEMENT NEEDS TO THEM? "WE" only have need of a PORTION of that which is to be made available and that, even, seems to be more than the usurpers wish to share even with the AGREEMENTS already established. I don't care if you are HEAD of the CIA—you are not in CHARGE! I HAVE BUILT MY FOUNDATION UPON WHICH I CAN BUILD OUR NEEDS—I DO NOT APPRECIATE PARTICIPANTS CONSIDERING IT THEIR DUTY TO TAKE OVER ANY PART OF SAME. IT WILL NOT HAPPEN.

NO GROUP

I have to repeat and repeat and repeat—for PROOF SEEMS NOT ENOUGH! THERE IS NO "GROUP" HERE OTHER THAN A GROUP OF

FRIENDS. THERE ARE NO STRINGS—NO BINDINGS. IF YOU PLAN TO WORK WITH ANY ONE OF THE BUSINESSES—IT HELPS TO HAVE BELIEF IN GOD AND INTEGRITY IN INTENT AND A TOTAL COMMITMENT TO DOING HONORABLE AND GOOD BUSINESS.

George Green continues to refer to ones here as a CULT—well the nearest there was EVER to a cult was when George Green went on a circuit pushing UFO connections. Those people, and Green, ARE GONE!

If we have a meeting, which we often do and it is other than a mere BUSINESS conference, visitors are welcome—no charge, no donation and no sign-in sheet. We are continually misrepresented by this—but confound it, we have friends in you readers who want to come to visit—and you shall always be welcome. Our enemies usually go forth and cause some immediate discomfort but there is never foundation upon which to base foolish claims or statements. We hide nothing for there is nothing to hide.

However, until you STOP considering the immediate workers as some sort of group-body then neither will our enemies. Ones of you in New Jersey are every bit as much a part of this GROUP as anyone here! Just because a man works for, or reads, *The New Yorker* magazine, does this make him a member of the *New Yorker* CULT?

We like everybody—red, yellow, black, brown, white and especially do we like purple and green people. We even like Baptists and Lutherans—although they don't like us much because I teach GOD'S LAWS. NOT MAN'S INTERPRETATION OF GOD'S LAWS—BUT, I DON'T INSIST YOU FOLLOW THEM!

INQUIRIES AND QUESTIONS REGARDING SPIRITUAL TRUTH

Please, do not stop writing with these questions or offering input on subjects as such it unfolds to you individually or from another. It is through the sharing that we grow and learn.

I will answer every question as we can do so—or I will tell you why I cannot or will not do so—as we share together. I cannot ask my scribe to individually respond to each and every personal inquiry. If it can be shared openly—thank you. We will always protect privacy. I even honor the reason and need of you to write to me through Dharma for it often helps to simply put a thought to paper and EXPRESS IT. You will usually have answered your own PERSONAL question if you will but go back and REALLY read your own letter to me.

YOU are THE CREATOR of your "future" and your "pathway"—not I. As a friend, I can help in understanding—but little more. If your desire has moved from service unto God to service unto Hatonn—it is incorrect direction and I DO NOT ACCEPT IT! WE ARE IN THIS THING TOGETHER! I KNOW THE WAY AND I KNOW HOW TO GET THERE—BUT I AM NOT DRAGGING ANYONE WITH ME. I MAY BE WILLING TO PUSH A BIT—BUT THAT INDICATES THAT I AM "BEHIND" YOU!

King "Bubba" Rains Down

Clintonistas Strike Again! A "Cozy" Dictatorship Forms Right Before Your Eyes

7/21/94 #1 HATONN

The following presentation is "hot" enough that it has been brought to me for consideration as to how to handle it. Well, it is not the "heat" of the document which is in point but rather the quality of the documents from the FAX machine.

Because I want this type of information dispersed along with the other usurper information—we need to put everything of this nature to computer disc for use now as well as later—and of course, for publication.

PRESIDENTIAL DECISION DIRECTIVE (PDD)-25

This is classified information and therefore I think that until I have clearance from parties involved—I will refrain from using sources for the information itself. Let us be grateful to have as much as has come through. We will type exactly as presented to us but readers must understand right up front that the last sentence or so of EACH FAX page is missing or so inked that it is not legible. In most instances it is not important so we will go with what we have and as others get copies perhaps you can fill in the missing portions or incorrect copy, please. This document has been so "classified" that even Senators have been unable to obtain a summary of it. We are under the impression that THIS is a summary. Senators seeking a summary have been denied

under the shelter of "Foreign Policy".

The source of this material we pass on has an information comment also: *"I am told that the President can issue an executive order, or PDD (Presidential Decision Directive), or similar order—legally. This was tested in the Supreme Court based on the powers of the Executive office."*

[QUOTING:]

[From intro to fax:] *"A President can also 'delegate' his power and authority, according to the court. This may soon be challenged."*

It is obvious by Executive Order 12919 [see p. 39 of the 7/19/94 CONTACT]—that the above is true in fact, even if not lawfully. These are the things you MUST attend, readers, as bit by mortal piece is torn away from your lives of freedom and Constitutional government.

THE CLINTON ADMINISTRATION'S POLICY ON REFORMING MULTILATERAL PEACE OPERATIONS MAY 1994 EXECUTIVE SUMMARY

Last year, President Clinton ordered an inter-agency review of our nation's peacekeeping policies and programs in order to develop a comprehensive policy framework suited to the realities of the post-Cold War period. This

policy review has resulted in a Presidential Decision Directive (PDD). The President signed this Directive, following the completion of extensive consultations with Members of Congress. This paper summarizes the key elements of that directive. [H: Wouldn't you like to know WHICH members of Congress?]

As specified in the "Bottom-Up Review," the primary mission of the U.S. Armed Forces remains to be prepared to fight and win two simultaneous regional conflicts. In this context, peacekeeping can be one useful tool to help prevent and resolve such conflicts before they pose direct threats to our national security. Peacekeeping can also serve U.S. interests by promoting democracy, regional security, and economic growth.

The policy directive (PDD) addresses six major issues of reform and improvement:

1. Making disciplined and coherent choices about which peace operations to support—both when we vote in the Security Council for UN peace operations and when we participate in such operations with U.S. troops.

To achieve this goal, the policy directive sets forth three increasingly rigorous standards of review for U.S. support for or participation in peace operations, with the most stringent applying to U.S. participation in missions that may involve combat. The policy directive affirms that peacekeeping can be a useful tool for advancing U.S. national security interests

in some circumstances, but both U.S. and UN involvement in peacekeeping must be selective and more effective.

2. Reducing U.S. costs for UN peace operations, both the percentage our nation pays for each operation and the cost of the operations themselves.

To achieve this goal, the policy directive orders that we work to reduce our peacekeeping assessment percentage from the current 31.7% to 25% by January 1, 1996, and proposes a number of specific steps to reduce the cost of UN peace operations.

3. Defining clearly our policy regarding the command and control of American military forces in UN peace operations.

The policy directive underscores the fact that the President will never relinquish command of U.S. forces. However, as Commander-in-chief, the President has the authority to place U.S. forces under the operational control of a foreign commander when doing so serves American security interests, just as American leaders have done numerous times since the Revolutionary War, including in Operation Desert Storm.

The greater the anticipated U.S. military role, the less likely it will be that the U.S. will agree to have a UN commander exercise overall operational control over U.S. forces. Any large scale participation of U.S. forces in a major peace enforcement operation that is likely to involve combat should ordinarily be conducted under U.S. command and operational control or through competent regional organizations such as NATO or ad hoc coalitions.

4. Reforming and improving the UN's capability to manage peace operations.

The policy recommends 11 steps to strengthen UN management of peace operations and directs U.S. support for strengthening the UN's planning, logistics, information and command and control capabilities.

5. Improving the way the U.S. government manages and funds peace operations.

The policy directive creates a new "shared responsibility" approach to managing and funding UN peace operations within the U.S. Government. Under this approach, the Department of Defense will take lead management and funding responsibility for those UN operations that involve U.S. combat units and those that are likely to involve combat, whether or not U.S. troops are involved. This approach will ensure that military expertise is brought to bear on those operations that have a significant military component.

The State Department will retain lead management and funding responsibility for traditional peacekeeping operations that do not involve U.S. combat units. In all cases, the State Department remains responsible for the conduct of diplomacy and instruction to embassies and our UN Mission in New York.

6. Creating better forms of cooperation between the Executive, the Congress and the American public on peace operations.

The policy directive sets out seven proposals for increasing and regularizing the flow of

information and consultation between the executive branch and Congress; the President believes U.S. support for and participation in UN peace operations can only succeed over the long term with the bipartisan support of Congress and the American people.

KEY ELEMENTS OF THE CLINTON ADMINISTRATION'S POLICY ON REFORMING MULTILATERAL PEACE OPERATIONS

INTRODUCTION:

The Role of Peace Operations in U.S. Foreign Policy. (For simplicity, the term peace operations is used in this document to mean the entire spectrum of activities from traditional peacekeeping to peace enforcement aimed at defusing and resolving international conflicts.)

Serious threats to the security of the United States still exist in the post-Cold War era. New threats will emerge. The United States remains committed to meeting such threats.

When our interests dictate, the U.S. must be willing and able to fight and win wars, unilaterally whenever necessary. To do so, we must create the required capabilities and maintain them ready to use. UN peace operations cannot substitute for this requirement.

Circumstances will arise, however, when multilateral action best serves U.S. interests in preserving or restoring peace. In such cases, the UN can be an important instrument for collective action. UN peace operations can also provide a "force multiplier" in our efforts to promote peace and stability.

During the Cold War, the United Nations could resort to multilateral peace operations only in the few cases when the interests of the Soviet Union and the West did not conflict. In the new strategic environment such operations can serve more often as a cost-effective tool to advance American as well as collective interests in maintaining peace in key regions and create global burden-sharing for peace.

Territorial disputes, armed ethnic conflicts, civil wars (many of which could spill across international borders) and the collapse of governmental authority in some states are among the current threats to peace. While many of these conflicts may not directly threaten American interests, their cumulative effect is significant. The UN has sought to play a constructive role in such situations by mediating disputes and obtaining agreement to cease-fires and political settlements. Where such agreements have been reached, the interposition of neutral forces under UN auspices has, in many cases, helped facilitate lasting peace.

UN peace operations have served important U.S. national interests. In Cambodia, UN efforts led to an election protected by peacekeepers, the return of hundreds of thousands of refugees and the end of a destabilizing regional conflict. In El Salvador, the UN sponsored elections and is helping to end a long and bitter civil war. The UN's supervision of Namibia's transition to independence removed a potential source of conflict in strategic southern Africa and promoted democracy. The UN in Cyprus has prevented the outbreak of war between two NATO allies. Peacekeeping on the Golan Heights has helped preserve peace between Israel and Syria. In Former Yugoslavia, the UN has provided badly-needed humanitarian assistance and helped prevent the conflict from spreading to other parts of the

region. UN-imposed sanctions against Iraq, coupled with the peacekeeping operation on the Kuwait border, are constraining Iraq's ability to threaten its neighbors. [H: Are you impressed or sick? This is pure unadulterated lies and garbage!]

Need for Reform

While serving U.S. interests, UN peace operations continue to require improvement and reform. Currently, each operation is created and managed separately, and economies of scale are lost. Likewise, further organizational changes at UN Headquarters would improve efficiency and effectiveness. A fully independent office of Inspector General should be established immediately. The U.S. assessment rate should be reduced to 25 per cent.

Since it is in our interest at times to support UN peace operations, it is also in our interest to seek to strengthen UN peacekeeping capabilities and to make operations less expensive in our interest to identify clearly and quickly those peace operations we will support and those we will not. Our policy establishes clear guidelines for making such decisions.

Role in U.S. Foreign Policy

UN and other multilateral peace operations will at times offer the best way to prevent, contain or resolve conflicts that could otherwise be more costly and deadly. In such cases, the U.S. benefits from having to bear only a share of the burden. We also benefit by being able to invoke the voice of the community of nations on behalf of a cause we support. Thus, establishment of a capability to conduct multilateral peace operations is part of our National Security Strategy and National Military Strategy.

While the President never relinquishes command of U.S. force, the participation of U.S. military personnel in UN operations can, in particular circumstances, serve U.S. interests. First, U.S. military participation may, at times, be necessary to persuade others to participate in operations that serve U.S. interests. Second, U.S. participation may be one way to exercise U.S. influence over an important UN mission, without unilaterally bearing the burden. Third, the U.S. may be called upon and choose to provide unique capabilities to important operations that other countries cannot.

In improving our capabilities for peace operations, we will not discard or weaken other tools for achieving U.S. objectives. If U.S. participation in a peace operation were to interfere with our basic military strategy, winning two major regional conflicts nearly simultaneously (as established in the Bottom Up Review), we would place our national interest uppermost. The U.S. will maintain the capability to act unilaterally or in coalition when our most significant interests and those of our friends and allies are at stake. Multilateral peace operations must, therefore, be placed in proper perspective among the instruments of U.S. foreign policy.

The U.S. does not support a standing UN army, nor will we earmark specific U.S. military units for participation in UN operations. We will provide information about U.S. capabilities for data bases and planning purposes.

It is not U.S. policy to seek to expand either the number of UN peace operations or U.S. involvement in such operations. Instead, this policy, which builds upon work begun by pre-

vious administrations and is informed by the concerns of the Congress that our use of peacekeeping is selective and more effective. Congress must also be actively involved in the continuing implementation of U.S. policy on peacekeeping.

* * *

I. Supporting the Right Peace Operations i. Voting New Peace Operations

The U.S. will support well-defined peace operations, generally as a tool to provide finite windows of opportunity to allow combatants to resolve their differences and failed societies to reconstitute themselves. Peace operations would not be open-ended commitments but instead linked to concrete political solutions; otherwise, they normally should not be undertaken. To the greatest extent possible, each UN peace operation should have a specified time frame tied to intermediate or final objectives, an integrated political/military strategy well-coordinated with humanitarian assistance efforts, specified troop levels, and a firm budget estimate. The U.S. will continue to urge the UN Secretariat and Security Council members to engage in rigorous, standard evaluations of all proposed new peace operations.

The Administration will consider the factors below when deciding whether to vote for a proposed new UN peace operation (Chapter VI or Chapter VII) or to support a regionally-sponsored peace operation:

* UN involvement advances U.S. interests, and there is an international community of interest for dealing with the problem on a multilateral basis.

* There is a threat to or breach of international peace and security, often of a regional character, defined as one or a combination of the following:

- * International aggression, or;
- * Urgent humanitarian disaster coupled with violence;
- * Sudden interruption of established democracy or gross violation of human rights coupled with violence, or threat of violence.
- * There are clear objectives and an understanding of where the mission fits on the spectrum between traditional peacekeeping and peace enforcement.

* For traditional (Chapter VI) peacekeeping operations, a cease-fire should be in place and the consent of the parties obtained before the force is deployed.

* For peace enforcement (Chapter VII) operations, the threat to international peace and security is considered significant.

* The means to accomplish the mission are available, including the forces, financing and a mandate appropriate to the mission.

* The political, economic and humanitarian consequences of inaction by the international community have been weighed and are considered unacceptable.

* The operation's anticipated duration is tied to clear objectives and realistic criteria for ending the operation.

These factors are an aid in decision-making; they do not by themselves constitute a prescriptive service. Decisions have been and will be based on the cumulative whole of the factors with no single factor necessarily being an absolute determinant. [line missing]

up for regular renewal by the Security Council to assess the value of continuing them. In appropriate cases, the U.S. will seek voluntary contributions by beneficiary nations or enhanced host nation support to reduce or cover, at least partially, the costs of certain UN operations. The U.S. will also consider voting against renewal of certain long-standing peace operations that are failing to meet established objectives in order to free military and financial resources for more pressing UN missions.

ii. Participating in UN and Other Peace Operations

The Administration will continue to apply even stricter standards when it assesses whether to recommend to the President that U.S. personnel participate in a given peace operation. In addition to the factors listed above, we will consider the following factors: **[H: Go read that again please. I thought the President IS the Administration???)**

* Participation advances U.S. interests and both the unique and general risks to American personnel have been weighed and are considered acceptable.

* Personnel, funds and other resources are available;

* U.S. participation is necessary for operation's success;

* The role of U.S. forces is tied to clear objectives and an endpoint for U.S. participation can be identified;

* Domestic and Congressional support exists or can be marshalled;

* Command and control arrangements are acceptable.

Additional, even more rigorous factors will be applied when there is the possibility of significant U.S. participation in Chapter VII operations that are likely to involve combat:

* There exists a determination to commit sufficient forces to achieve clearly defined objectives;

* There exists a plan to achieve those objectives decisively;

* There exists a commitment to reassess and adjust, as necessary, the size, composition, and disposition of our forces to achieve our objectives.

Any recommendation to the President will be based on the cumulative weight of the above factors, with no single factor of the above being an absolute determinant.

II. The Role of Regional Organizations

In some cases, the appropriate way to perform peace operations will be to involve regional organizations. The U.S. will continue to emphasize the UN as the primary international body with the authority to conduct peacekeeping operations. At the same time, the U.S. will support efforts to improve regional organizations' peacekeeping capabilities.

When regional organizations or groupings seek to conduct peacekeeping with UNSC [UN Security Council] endorsement, U.S. support will be conditioned on adherence to the principles of the UN Charter and meeting established UNSC criteria, including neutrality, consent of the conflicting parties, formal UNSC oversight and finite, renewal mandates.

With respect to the question of peacekeeping in the territory of the former Soviet Union, requests for "traditional" UN blue-helmeted operations will be considered on the same basis as other requests, using the factors previously outlined (e.g., a threat to international peace and security, clear objectives, etc.). U.S. support for these operations will, as with other such requests, be conditioned on adherence to the principles of the UN Charter and established UNSC criteria.

III. Reducing Costs

Although peacekeeping can be a good investment for the U.S., it would be better and more sustainable if it cost less. The Administration is committed to reducing the U.S. share of peacekeeping costs to 25% by January 1, 1996, down from the current rate of 31.7%. We will also inform the UN of Congress's likely refusal to fund U.S. peacekeeping assessments at a rate higher than 25% after Fiscal Year 1996.

The Administration remains concerned that the UN has not rectified management inefficiencies that result in excessive costs and, on occasion, fraud and abuse. As a matter of priority, the U.S. will continue to press for

GaiaLyte Program Now Available

PROGRAM STARTING PACKAGE

- 1 Bottle Gaiandriana (1 Quart)
- 1 Bottle AquaGaia (1 Quart)
- 2 Bottles GaiaLyte (2 Liters each)
- 4 Packages Spelt Bread Mix
- 5 Audio-cassettes

COST: \$150 (for CONTACT Subscribers only)
\$180 (for non-subscribers)

MAINTENANCE PACKAGE

- 1 Bottle Gaiandriana (1 Quart)
 - 2 Bottles GaiaLyte (2 Liters each)
 - 4 Packages Spelt Bread Mix
- COST: \$90.00 (for CONTACT subscribers only)
\$115 (for non-subscribers)

GaiaSorb

NEUTRA-BOND: 2 oz.
NICOTINE, CAFFEINE, ALCOHOL
SUCROSE, STARCH, \$6.00 each
TRAVEL PACK: 1/2-oz.
bottles of each of the above,
plus Gaiandriana, for \$15.00
(plus shipping and handling).

New Gaia Products
P.O. Box 27710

Las Vegas, NV 89126

For credit card orders, call:
1 (800) NEW-GAIA (639-4242)
We accept Discover, Visa & Master Card
Please make all checks and money orders
payable to: *New Gaia Products*
(See Next-To-Last Page for Order Form)

dramatic administrative and management improvements in the UN system. In particular, the U.S. is working hard to insure that new and on-going peace operations are cost-effective and properly managed. Towards this end, the U.S. is pursuing a number of finance and budget management reforms, including:

- * immediate establishment of a permanent, fully independent office of Inspector General with oversight responsibility that included peacekeeping.
- * unified budget for all peace operations, with a contingency fund, financed by a single annual peacekeeping assessment;
- * standing cadre of professional budget experts from member states, particularly top contributing countries, to assist the UN in developing credible budgets and financial plans;
- * enlargement of the revolving peacekeeping reserve fund to \$500 million, using voluntary contributions;
- * required status of forces/mission agreements that provide preferential host nation support to peacekeeping operations;
- * prohibit UN "borrowing" from peacekeeping funds to finance cash shortfalls in regular UN administrative operations;
- * revise the special peacekeeping scale of assessments to base it on a 3-year average of national income and rationalize Group C so that higher income countries pay their regular budget rate.

Moreover, the U.S. will use its voice and vote in the Fifth Committee of the General Assembly of the United Nations to contain costs of UN peace operations once they are underway.

IV. Strengthening the UN

If peace operations are to be effective and efficient when the U.S. believes they are necessary, the UN must improve the way peace operations are managed. Our goal is not to create a global high command but to enable the UN to manage its existing load more effectively. At present each UN operation is created and managed separately by a still somewhat understaffed UN Department of Peacekeeping Operations (DPKO). As a result, support to the field may suffer, economies of scale are lost, capabilities, particularly in complex operations, need substantial improvement. Structural changes at UN Headquarters, some of which are already underway, would make a positive difference.

A. The U.S. proposals include the reconfiguration and expansion of the staff for the Department of Peacekeeping Operations to create:

- * Plans Division to conduct adequate advance planning and preparation for new and on-going operations;
- * Information and Research Division linked to field operations to obtain and provide current information [line missing]
- * Operations Division with a modern command, control and communications (C3) architecture based on commercial systems;
- * Logistics Division to manage both competitive commercial contracts (which should be re-bid regularly on the basis of price and performance) and a cost-effective logistics computer network to link the UN DPKO with logistics offices in participating member nations. This system would enable the UN to request price and availability data and to order mate-

riel from participating states;

- * Small Public Affairs cell dedicated to supporting on-going peace operations and disseminating information within host countries in order to reduce risks to UN personnel and increase the potential for mission success;
- * Small Civilian Police Cell to manage police missions, plan for the establishment of police and judicial institutions, and develop standard procedures, doctrine and training.

B. To eliminate lengthy, potentially disastrous delays after a mission has been authorized, the UN should establish:

- * a rapidly deployable headquarters team, a composite initial logistics support unit, and open, pre-negotiated commercial contracts for logistics support in new missions;
- * data base of specific, potentially available forces or capabilities that nations could provide for the full range of peacekeeping and humanitarian operations;
- * trained civilian reserve corps to serve as a ready, external talent pool to assist in the administration, management, and execution of UN peace operations;
- * modest airlift capability available through pre-negotiated contracts with commercial firms or member states to support urgent deployments.

C. Finally, the UN should establish a professional Peace Operations Training Program for commanders and other military and civilian personnel.

D. Consistent with the global objectives outlined above, the U.S. will actively support efforts in the Fifth Committee of the —[line missing].

- * detail appropriate numbers of civilian and military personnel to DPKO in New York in advisory or support roles;
- * share information, as appropriate, while ensuring full protection of sources and methods;
- * offer to design a command, control, and communications systems architecture for the Operations Division, using commercially available systems and software;
- * offer to assist DPKO to establish an improved, cost-effective logistics system to support UN peacekeeping operations;
- * offer to help design the database of military forces or capabilities and to notify DPKO, for inclusion in the database, of specific U.S. capabilities that could be made available for the full spectrum of peacekeeping or humanitarian operations. U.S. notification in no way implies a commitment to provide those capabilities, if asked by the UN;
- * detail public affairs specialists to the UN;

* offer to help create and establish a training program, participate in peacekeeping training efforts and offer the use of U.S. facilities for training purposes. [H: Go back and read it again!]

V. Command and Control of U.S. Forces

A. Our Policy: The President retains and will never relinquish command authority over U.S. forces. On a case by case basis, the President will consider placing appropriate U.S. forces under the operational control of a competent UN commander for specific UN operations authorized by the Security Council. The greater the U.S. military role, the less likely it will be that the U.S. will agree to have a UN commander exercise overall operational control over U.S. forces. Any large scale participation of U.S. forces in a major peace enforcement mission that is likely to involve combat should ordinarily be conducted under U.S. command and operational control or through competent regional organizations such as NATO or ad hoc coalition.

[H: I want to interrupt here (I actually think I have contained myself quite admirably so far) because I want to remind you of something—THIS DOCUMENT DOESN'T SAY ANYTHING AS TO GUIDELINES—REALLY. ANYTHING CAN BE INTERPRETED ANY WAY ANYONE IN POWER WANTS TO INTERPRET IT—JUST LIKE YOUR NEWSTATES CONSTITUTION. BESIDES, YOU HAD BETTER REMEMBER THE U.N. CHARTER—ANY UN FORCES ARE GOING TO, BY CHARTER, BE HEADED BY RUSSIAN COMMAND!!!]

There is nothing new about this Administration's policy regarding the command and control of U.S. forces. [H: Well, you JUST GOT IT! WITH A STATEMENT LIKE THAT YOU KNOW YOU ARE "HAD"!] U.S. military personnel have participated in UN peace operations since 1948. American forces have served under the operational control of foreign commanders since the Revolutionary War, including in World War I, World War II, Operation Desert Storm and in NATO since its inception. We have done so and will continue to do so when the President determines it serves U.S. national interests.

[END OF QUOTING]

This has been a bitch to do and our scribe is now in an incredibly bad mood! Maybe Rick can get a phone call through and get "whoever" to read him off that which I couldn't translate or was simply missing—I think I got most all of it correctly decoded elsewhere. Thank you, Dharma, and Salu.



The News Desk

7/20/94 RICK MARTIN

SAGAN & UFOs

In an Associated Press article appearing in the June 25 edition of the *ALBANY DEMOCRAT-HERALD*, [quoting:]

So you believe earth has been visited by unidentified flying objects and the evidence has been suppressed by the government?

That hypnosis or psychotherapy can enable you to recover memories from before you were born?

That creatures from outer space regularly abduct humans, subject them to sexual abuse and use them for breeding experiments with aliens?

Well, you have plenty of company, and that makes you a part of one of the biggest problems in the world of science, astronomer Carl Sagan and other debunkers of pseudoscientific misconceptions said Friday.

"It's not that we're grumpy about lost continents or UFOs," Sagan said—it's that the world can ill afford such scientific illiteracy.

Surveys indicate 25 percent to 50 percent of adult U.S. citizens "don't know the earth goes around the sun once a year," Sagan said.

"Almost every newspaper in the United States has an astrology column, and none has a daily science column. Some have a weekly science column. Why is that?" he asked. "When is the last time you heard an intelligent remark on science from a president of the United States?"

[I would like to take an opportunity, right here and now, to invite Carl Sagan to contact me for an interview at (800) 800-5565. As a member of MJ-12, I'm sure Dr. Sagan could dispel many of the myths, inaccuracies, and flat lies that have been circulating about our space brothers for years and years. He might even help fill in some of the gaps about what their real purposes are for being here. The question is, will he? The CONTACT, as anyone who has read my interviews will attest, will publish word for word what is shared. It just might be an excellent opportunity, Carl, to reach some people you may not normally be able to reach. Just a thought; nevertheless, I am open to hear from you and would welcome the opportunity for some friendly and frank discussion on these and related matters.]

FOREST SERVICE UFO SIGHTINGS

In an article from the June 27 edition of the *STATESMAN JOURNAL*, OAKRIDGE, (OR) [quoting:]

It took a gathering of Forest Service veterans posted at lonely lookouts during their careers to bring out some experiences none of them wanted to admit—UFO sightings.

Just as conference participants were sitting down to dinner at a restaurant near Oakridge recently, Jim Doerter announced that he had seen a red and white spinning disk perhaps 1,000 feet across during his service at Flat Top Lookout near Mount St. Helens in 1959.

Doerter said he saw the UFO travel the 50

miles from Mount Hood in Oregon to Mount Adams in Washington in 40 seconds, one of two close encounters he had that summer.

His wife, Martha, attending the banquet with him, said she also had seen the object.

"It looked like a mercury-vapor lamp," she said. "I thought I could see windows."

When Ron Johnson, director of the Oregon chapter of the Forest Fire Lookout Association, asked who else had seen similar things while on lookout duty, a dozen hands went up.

Several lookouts said they had not reported the UFOs because they didn't want their district rangers to think that they had lost their minds.

Bill Friday said a large, bluish-white disk had awakened him one night in the summer of 1974 when he was serving on Illahee Rock Lookout on Southern Oregon's Umpqua River. It was so bright, he said, that he could still see it when he pulled his sleeping bag over his head.

"I was in a cold sweat, and the hair stood up on my neck," he said. "It was very real."

RUMORS OF PEACE

In an article appearing in the July 19 edition of *THE LOS ANGELES TIMES*, written by Robin Wright, JERUSALEM—[quoting:]

On the first day of his sixth Mideast shuttle, Secretary of State Warren Christopher talked with Israeli leaders Monday and predicted that the peace process is close to realizing its goal. [Oh?]

"The Arab-Israeli conflict, one of the most longstanding and most intractable conflicts of this entire century, is drawing to an end," he said after meeting with Israeli Prime Minister Yitzhak Rabin. "There will be difficulties on the path ahead. But, nonetheless, we're proceeding to assist the parties and they are proceeding with great determination."

Christopher called his weeklong trip before next Monday's planned summit between Rabin and Jordan's King Hussein in Washington "these historic seven days."

But there was little tangible progress to back up his optimism. While Israeli officials are encouraged by the momentum created with the latest breakthrough on the Jordanian negotiating front, they said Monday they did not share U.S. optimism about progress with Syria.

GONZALEZ OPPOSES FOSTER PROBE

In an article from the June 27 edition of the *NATIONAL WEEKLY EDITION* of *THE WASHINGTON TIMES*, written by Jerry Seper, [quoting:]

House Banking Committee Chairman Henry B. Gonzalez has told the Democratic leadership he does not want Vincent W. Foster Jr.'s suicide [murder] to be part of Whitewater-Madison hearings and opposes a timetable for the hearings.

In a letter to House Speaker Thomas S. Foley, Washington Democrat, Mr. Gonzalez said, "I look forward to meeting with the leadership soon to discuss hearings."

The Democratic leadership has proposed hearings within 30 days after Mr. Fiske completes the first phase of his investigation. He is expected to finish sometime in late July.

Mr. Gonzalez said the hearings should look into contacts between the White House and federal regulators in the Whitewater-Madison affair and the handling of Mr. Foster's papers after his suicide.

He said the panel does not have the expertise to conduct a review into the death of the White House deputy counsel and suggested it be dropped as a hearings topic.

"No Congressional committee is in any way capable of acting as coroner or homicide investigator, even if there were some legislative purpose to be served in pursuing this issue," the Texas Democrat said. "I believe the investigative work of federal and local police agencies and by [Mr. Fiske] should be sufficient.

"I would urge that this subject be deleted, on the ground it lacks legitimate purpose, the Congress is ill-equipped to undertake the task, and any congressional review would inevitably be criticized rightfully as inept," he said.

"The issue here is properly a police question, not a legislative issue," he said. "An investigation of the handling of papers necessarily opens the issue of the contents of the papers—matters that Mr. Fiske has asked that we not address."

NEW BLOOD SUBSTITUTES

New blood

Why blood substitutes were developed

- Creates a virus-free blood supply
- No blood type limitations
- Longer shelf life than real blood: a year compared with 5 weeks
- Could prevent blood shortages

Sources of blood substitute

- Human blood
- Animal blood, typically from cows or pigs
- Genetically altered bacteria

Problems with substitutes

- Some tests with animal and bacteria-based blood substitutes caused kidney problems or fevers
- Passes out of the system more quickly than real blood

TOM VALENTINE

In an article from the July 11 edition of *SPOTLIGHT*, [quoting:]

There's good news for those of you who own satellite dishes. Sun Radio has announced that *SPOTLIGHT'S* *Radio Free America*, hosted by Tom Valentine, has moved to one of the best satellites available. Previously, many people have had trouble receiving Tom's popular show.

You can find him on Satcom 1, 137 degrees West, Transponder 15, 7.56 audio. The visual signal that accompanies the audio broadcast is scrambled, and will not distract from your enjoyment of the show.

NEW MICROSCOPE

In an article from the July 10 edition of the *SAN FRANCISCO EXAMINER*, [quoting:]

Researchers at a foundation in Kawasaki, near Tokyo, have developed a microscope that can analyze consecutive cross sections of minute organisms and duplicate them as 3-D images.

A team working under Toshiro Higuchi, a professor in the engineering faculty at Tokyo University who heads the research division at the Kanagawa Academy of Science and Technology in Kawasaki, developed the microscope.

RUSSIAN TANKS IN U.S.A.

In an article from the July 11 edition of *SPOTLIGHT*, Mike Blair writes, [quoting:]

Two Russian heavy tanks have been spotted along an interstate highway in western Texas.

Two flatbed trucks carrying one each Russian T-72 main heavy battle tank were first spotted heading west at the Highway 10 258-mile marker and exited at marker 257 to turn into the truck stop.

Numerous witnesses spotted the tanks while their truck carriers were parked in the far eastern area of the truck parking lot, facing northwest.

Witnesses reported that the tractors hauling the huge trailers and tanks were all white and the doors bore decals, "Trism Specialty Carriers." There was no address or other details on the doors.

The plate on the grille of one of the trucks bore Oklahoma license number ID095723 and it was also marked with a company number, 24824.

One of the Russian tanks appeared "like new", with fresh dark green/gray-green paint. The other had a multi-color camouflage paint scheme—light and dark green and tan—and looked older

and weathered.

Both tanks were fully equipped with external gear, including fuel drums. The mounts for the tanks' turret-mounted 12.7 millimeter machine guns were attached, although the guns were not in the mounts and it was believed they were probably inside the tanks, where they are usually placed while being transported.

The tank with the fresh paint bore the markings "A30" on the side...

It is believed that the haulers continued to travel west after leaving the truck stop.

A similar sighting of what appeared to be Russian jeep-type vehicles was reported to *SPOTLIGHT* to have taken place on May 9 in Riggins, Idaho.

The vehicles—both painted flat white inside and out, the usual paint scheme of UN vehicles—were aboard an 18-wheel flatbed truck headed north and parked in front of the Riggins Post Office. The truck bore a sign indicating it belonged to Mega Trucking of Nevada, truck number 1318, and bore the license number AA 3263.

Meanwhile, reports of activity at the truck depot just south of Saucier, Mississippi, about 45 miles north of Biloxi along Mississippi Highway 49, continue.

CRIMINALS EXILED

In an article from the July 15 edition of *THE ORLANDO SENTINEL*, EVERETT, Wash.—[quoting:]

The crime: another violent, small-change urban robbery. The criminals: Two rural teenage Alaska Tlingits. The punishment: Banishment for one year on uninhabited islands with only hand tools and a little food.

And for the victim: a new dwelling.

An experiment in cross-cultural jurisprudence was set in motion in a Washington state courtroom when a judge agreed to go along with old-fashioned tribal justice.

The world's biggest companies

Fortune magazine's Global 500 lists the top 500 industrial companies in the world, according to sales:

The countries with the most companies on the global 500

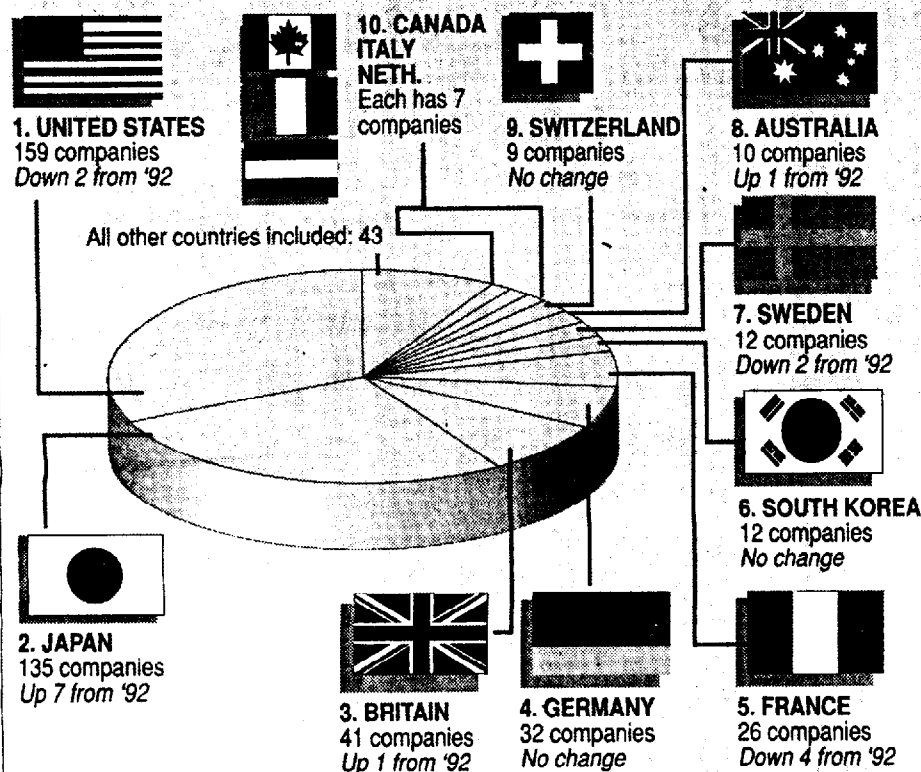

Top companies in 15 industries

Industry	Company	Global 500 rank	Sales \$ millions
Aerospace	Boeing	#47	\$25,285
Apparel	Levi Strauss	#253	\$5,892
Beverages	PepsiCo	#48	\$25,021
Building materials, glass	Saint-Gobain	#107	\$12,630
Chemicals	Du Pont	#30	\$32,621
Computer, office equip.	IBM	#7	\$62,716
Electronics, electrical equip.	Hitachi	#6	\$68,582
Food	Phillip Morris	#15	\$50,621
Forest and paper products	International Paper	#99	\$13,685
Industrial and farm equip.	Mitsubishi Heavy Ind.	#43	\$25,804
Jewelry, silverware	Citizen Watch	#406	\$3,501
Metal products	Pechiney	#130	\$11,127
Metals	IRI	#16	\$50,488
Mining, crude-oil production	Ruhrkohle	#91	\$14,155
Motor vehicles and parts	General Motors	#1	\$133,622

Corn is king

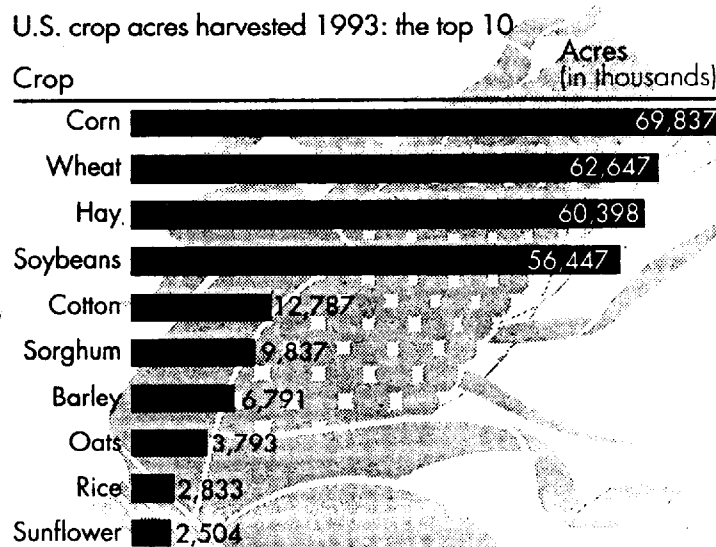

Source: USDA, National Agriculture Statistics Service

CROP LOOK: More acres of U.S. farmland are given over to growing corn than to any other crop. Wheat and hay, No. 2 and No. 3 respectively, aren't far behind.

According to Washington law, Alaskans Adrian J. Guthrie and Simon P. Roberts, both 17 and Tlingit natives of southeast Alaska, faced from three to 5 1/2 years in prison after pleading guilty to the robbery of a pizza delivery man in Everett last summer. The victim was severely beaten with a baseball bat; his hearing has been affected.

In such violent crimes, Washington law specifically calls for punishment, not rehabilitation. And the chance of restitution in such cases is remote.

But Wednesday, Superior Court Judge James Allendoerfer listened sympathetically and gave the go-ahead to a different approach, the Tlingit way. He agreed to release the teenagers to custody of a tribal court for imposition of the sentence of one year's banishment and restitution to the victim.

Prosecutors objected to the experiment, arguing that it would open the door to all sorts of cultural exceptions and challenges to state law.

"A balancing of the books," explained public defender Al Kitching. "Without that, these young men will never be accepted back in the tribe."

NATIONAL ENDOWMENT FOR THE ARTS

In an article from the June 27-July 3 edition of the *NATIONAL WEEKLY EDITION*, Rob Dreher of *THE WASHINGTON TIMES* writes, [quoting:]

Jane Alexander, chairman of the National Endowment for the Arts, responded to criticism of a bloody, NEA-funded stage act by an HIV-positive performer in part by decrying media "exaggerations".

The March 5 event, witnessed by an audience of 100, featured Ron Athey, who is infected with the virus that causes AIDS, piercing his body with needles, carving designs into the bare back of an assistant, daubing the resulting blood with paper towels and sending the towels over the heads of the audience.

It drew immediate criticism from Sen. Robert C. Byrd, West Virginia Democrat and chairman of the Senate Appropriations Committee, and Sen. Don Nickles, Oklahoma Republican. They wrote Miss Alexander asking her to explain how the performance passed "the test of artistic excellence and artistic merit, by which applications for NEA funding are to be judged."

"With respect to the Athey performance itself, his work is a study exploring modern-day martyrdom as it relates to AIDS," Miss Alexander said in her letter to Mr. Byrd. "It is a very disturbing but important contemporary subject."

[It's disturbing alright—it's disturbing that the NEA continues to fund such events with your tax dollars!]

In an article from the July edition of *AFA*, [quoting:]

This is what your taxes, through the National Endowment for the Arts, recently supported at the Woolly Mammoth Theatre, Washington, D.C., according to *THE WASHINGTON, D.C. CITY PAPER* (4/8/94) AND *THE WASHINGTON POST* (4/1/94).

In a review of a performance titled *My Queer Body*, the *CITY PAPER* said homosexual performance artist Tim Miller asks audience members to identify body parts as he does an impromptu illustrative dance. "Ankle," "tibia," "chest," and "forehead" are named. The identification of "anus" prompts an "exultant

smile" from Miller.

Miller presented a series of "taboo-flaunting vignettes and fantasies" including stories of his homosexual teenage years, when he remembers "sleeping with another boy in the bed I was born in—the bed in which I would be born once again."

On stage he strips naked and sits in the lap of a front row patron to "conduct a short discourse on the nervous-making aspects of what he's doing."

He stands nude on stage for 20 minutes. At one point he offers a "lengthy, explicit description of homosexual lovemaking." A *POST* review said the show concluded with Miller attempting to will himself to erection.

Miller, a self-described "loud, obnoxious fag," came to the nation's attention as one of the "NEA Four," who sued the NEA when his funding was withdrawn several years ago. He continues to receive NEA grants, as does the Woolly Mammoth Theatre.

TREASURY

In an article from the June 20 edition of *INSURANCE ACCOUNTANT*, [quoting:]

Stanley E. Morris, a former adjuster for Continental Insurance in New York, has been named to head the Department of Treasury's Financial Crimes Enforcement Network and is

asking financial institutions for their cooperation in detecting, investigation and prosecuting financial crimes.

Morris is the first to head the new alliance between FinCEN and Treasury's Office of Financial Enforcement, a partnership announced May 18. The merger creates what could become one of Treasury's most powerful departments combining FinCEN's analytical and intelligence responsibilities with OFE's regulatory and oversight capabilities.

MALARIA STATESIDE

In an article from the July 7 edition of *THE DENVER POST*, [quoting:]

For the first time in more than four decades, residents of metropolitan New York have contracted malaria from local mosquitoes, federal health officials said yesterday.

Three of the cases occurred last July in the New York City borough of Queens, startling city health officials who this year, for the first time in recent memory, are regularly trapping theinsects and testing them for the disease. Two other cases, reported today in the *NEW ENGLAND JOURNAL OF MEDICINE*, were seen in New Jersey in 1991.

LAWRENCE LIVERMORE HACKERS

In an article from the July 12 edition of *THE MODESTO BEE*, [quoting:]

Dramatically illustrating the security problems posed by the rapid growth of the Internet computer network, one of the nation's three nuclear weapons labs confirmed Monday that computer hackers were using its computers to store and distribute hardcore pornography.

Embarrassed officials at Lawrence Livermore National Laboratory, which conducts a great deal of classified research and has highly sophisticated security procedures, said the incident was among the most serious breaches of computer security ever at the lab.

The offending computer, which was shut down after a *LOS ANGELES TIMES* reporter investigating Internet hacking alerted lab officials, contained more than 1,000

New U.S. currency design

Here are some of the features of a new \$100 bill being proposed by the U.S. Treasury. Final design will be announced in 1995 and distribution will start in 1996.

- Watermark of Franklin portrait:** Visible held up to light; doesn't copy on color copiers.
- Color shifting ink:** Changes color when viewed from different angles.
- Denomination threads:** Embedded in bill with a different location for each bill size.
- Intaglio microprinting:** Too small to be reproduced on a copier.
- Portrait:** Larger off-center image of Benjamin Franklin.

Reasons for redesign

- To deter counterfeiting with advanced copiers, scanners and printers
- To thwart counterfeiting of U.S. currency in foreign countries

Note: Currency will remain the same size and color; old currency will still be useable.

SOURCE: Treasury Department

pornographic images. It was believed to be the largest cache of illegal hard-core pornography ever found on a computer network.

BANANAS

In an article from the July 9 edition of *THE ALBUQUERQUE JOURNAL*, written by Richard Cole, [quoting:]

In the beginning, science created the genetically altered tomato, and the government looked upon it, and saw that it was good.

Now it's time for the banana, say two biotech companies who've signed an agreement to develop a slow-ripening fruit that tastes better and has a longer shelf-life.

Oakland-based DNA Plant Technology and Zeneca Plant Science of Wilmington, Del. also hope to introduce some exotic varieties of the banana, the U.S.'s second most popular fruit after the apple.

It could be three to five years before the new product reaches store shelves...

CARROTS

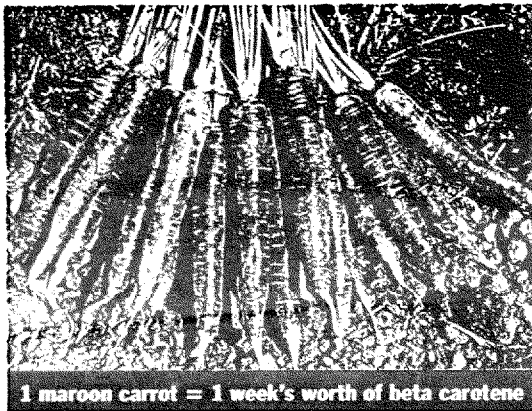

Souped-up veggies

When is an apple not an apple? When it's a carrot that tastes like an apple. Confused? Researchers at Texas A&M's new Vegetable Improvement Center are breeding veggies for much more than better taste or longer shelf life, like the famous DNA-doctored tomato. They're packing foods with more of the compounds that help prevent heart disease or cancer. Creations include those apple-flavored carrots, grapefruit-sized onions and, due next spring, maroon-tinted carrots with added beta carotene. (Yes, maroon is one of the college's colors.)

7/20/94 Ed Cleary

GOLD PRICE ON SAT. JULY 23, 1994
N.Y. COMEX: \$385.00/oz.

L.A. RELIGION

Commentary on the Religion section of the *L.A. Daily News* and the *Bakersfield Californian* appearing Saturday, July 16, 1994.

The headline articles include:

a) The Pope is publishing a book *Crossing The Threshold of Hope* in the fall and Random House is shelling out 7 million up front to get the rights.

b) Harold Camping, owner of 40 radio stations under *Family Radio* label with annual income of 12 million predicts the end of the world in September '94.

c) The Mormon Church with its nearly 9 million membership does not allow active opposition to the church, its programs and its doctrines.

d) Not to be outdone by the race, color, sex, ethnicity, age and disability opposition to harassment, the opponents of Religious harassment in the workplace are becoming vocal and active.

e) Gallup Poll reports big decline in the nation's morality.

f) U.S. politicians have no understanding of the importance of religion in some foreign countries' policies.

Throughout the U.S. a Religion Page is printed in the Saturday edition of most newspapers. The page is filled with 1) commercial ads and, 2) drivel such as appears above.

The entire six-column spread about the Pope's book deals with the money and marketing aspects. A two-liner states "The book is a discussion of Roman Catholicism and how it relates to the modern era" If I know anything about papal writings (and I do) it will be as incomprehensible and dull as have been all the papal writings since Leo XIII published *Rerum Novarum* in 1893. Yet Pope J.P. II will get 7 million while Colin Powell only got about 6.5 million and Schwarzkopf is reported to get a mere 5 million for his effort.

You really have to read for yourself what this religious moron with all the radio stations [*Camping*] is saying. Here are excerpts from the story by David Briggs:

"In two books and a nightly national radio talk show, *Camping* has convinced thousands that on one day in September, the 'saved' will be raised up, and the 'unsaved' living and dead will be condemned to everlasting damnation.

"The judgement throne is coming. In a few days it will be here," *Camping* said in a telephone interview from his office in Oakland.

"According to *Camping's* dateline, the period of tribulation forecast in biblical books as leading up to the end began in May 1988, 13,000 years after the world was created in 11,013 B.C. It was in 1988 that Satan was turned loose on the Earth and churches have been teaching what he calls 'false gospels' that ignore the concepts of hell and damnation.

"Working from the May 1988 date, he arrived at September 1994 as the date of the end of the world by taking literally a reference in the eighth chapter of the *Book of Daniel* to a vision of a sanctuary being rebuilt 2,300 days after it was desecrated."

I rest my case.

About the vote on the nation's declining morality the recent Gallup Poll states that 62% thinks society is getting worse. It was 48% in 1984. *Newsweek*, early on in '94, polled this questions: "Do you think the U.S. is in a moral and spiritual decline?". Of those polled 76% said yes.

After this, Jada Gallagher, the *Californian* staff writer, took her own poll. Polled were the rabbi, the conservatives, the congressman, the Baptist, the Methodist, the Catholic, the Muslim, and guess what? They all agreed 100% on the decline.

The Presbyterian fellow voted for—a spiritual rebirth is on. And get this one. That great expert and authority on morality, Senator Pete Domenici, R-New Mexico, is going to fix it all with his CHARACTER COUNTS WEEK, a school program to promote respect, responsibility and honesty.

Not only is TRUTH and MORALITY taking a beating all over the world but even more so the darkness of ignorance enshrouds the intelligence of human kind.

EUROPEAN DIVISION

In an article from the July 4 edition of the *Johnson City Press*, Vienna,—[quoting]: Russian nationalist Vladimir Zhirinovskiy, in Vienna for a meeting of European parliamentarians, predicted Sunday that Europe would again divide into two halves, East and West, because Easterners felt let down by the lack of action taken on Western promises after the end of Communism.

THE FLIGHT FROM ORGANIZED RELIGIONS

In an article from the July 2 edition of the *Johnson City Press*—[quoting]: Beginning when their children reach their teens, older baby boomers are showing signs of going to church less often. When the kids leave home, the first empty nest boomers are showing an even more dramatic decline in church attendance, according to new research by sociologist David Roozen of Hartford Seminary.

No generation may have had more of an impact on American religion than the baby boomers, born between 1946 and 1965. The heights of membership and church attendance were achieved in the 1950s and early '60s when baby boomers were children.

But they left churches in large numbers in the late '60s and 1970s—a time when institutions were under attack and many viewed organized religion as irrelevant. Mainline Protestant churches were the hardest hit, losing millions of members all the way through the 1980s.

Just 37 percent of baby boomers born between 1946 and 1955 with children no longer at home reported attending church regularly in 1990.

And the downward trend is noticeable even before they have an empty nest. Forty-five percent of older baby boomers with teenage children reported being regular church attenders in 1990.

[E.C.—This church avoidance is but another sign of the end of a cycle.]

DEMOCRACY, CRIMINALS AND RUSSIA

From the seed of "Democracy" an evil offspring has been birthed in Russia after a short gestation period and gives great promise of leeching the lifeblood from its father, mother and the entire family.

The evil is spreading into neighboring peoples and communities and is beginning to affect countries across the Great Waters.

The following excerpts from the July 25 issue of *Newsweek* written by Melinda Liv and Betsy McKay illustrate this activity and provoke remembrance of an historical era in the U.S. when Capone and Chicago were the headlines. Then as now, Eliot Ness (Freeh) and the FBI rise to the challenge. The result will probably be the same. Gangsters will change into the costumes of bankers and businessman. The show will go on.

"Gen. Mikhail Yegorov wanted the cookout to be an occasion his guest of honor would remember, however hazily. When FBI chief Louis Freeh arrived at the remote country

dacha, the Russian first deputy interior minister welcomed him with swirling Gypsy dancers, roast suckling pig and plenty of liquid refreshment.

"They had reason to celebrate. The object of Freeh's trip was to promote cooperation in both countries' fight against the increasing global reach of Russia's racketeers. The centerpiece of Freeh's Moscow visit was the formal launching of an FBI liaison office there, scheduled to open in October. By Yegorov's own estimate, his country has 5,700 gangs, totaling 100,000 members; other estimates run far higher. In this year's first quarter, Russia averaged 84 murders a day, many of them contract killings tied to extortion schemes. The mobsters' activities are corroding Russia's fragile legal system and creating an international network to make Russia 'the superpower of crime'.

"Law-enforcement officials across Europe fear the expanding influence of Russian criminals. The ugliest danger is that the mobsters' greed might help make the threat of nuclear terrorism a fact. In Berlin, German officials told Freeh they'd stumbled onto a cache of weapons-grade plutonium in May. Investigators think it was smuggled out of a nuclear-research institute near Moscow.

"Even without the nuclear risk, the gangsters' unchecked activities could produce disaster: they could sabotage Russia's efforts to reform itself. Hopes for democracy's survival depend on getting the national economy up and running; the mob, meanwhile, stifles competition, encourages official corruption and deters foreign investment. According to a U.S. Embassy official in Moscow, at least 80 percent of all Russian businessmen are believed to have links with organized crime.

"**Thugs' demands:** Now foreign companies have begun feeling the squeeze. Recently the Moscow office of the U.S. Chamber of Commerce received a visit from a pair of thugs who demanded the names, addresses and phone numbers of all 230 member companies doing business in Russia.

"Until now, the Russian government has been ineffective against the outlaws. Underpaid cops, lacking up-to-date equipment, despair of matching the mob's resources. Last month Yeltsin declared war on 'gangsterism', ordering a roundup of alleged gang members and authorizing their detention without charges for up to 30 days. But there's no law on the Russian books against merely being known as a mobster. Civil libertarians say Yeltsin's tactic can only bring a return of the old Soviet police state—but many residents are nostalgic for the security of totalitarian rule.

"Freeh sees no alternative to the alliance. 'The only [other] option is to not deal with the Russians at all,' he says. 'I'm not willing to ignore Russian organized crime the way we ignored La Cosa Nostra for 50 years.' In the meantime, Russia's residents are finding their own ways to cope. One American businessman who opened a fancy new restaurant in Moscow this spring researched the city's top crime organizations, chose one and called to make a deal. Members of three rival gangs visited him in the first days of operation. All he had to do, he says, was to pick up the phone. No one bothered him again."

Now mother Russia is in quite a bind. What a choice! Bolshevism and Big Thugs or "democracy" and little thugs growing up to be BIG THUGS.

The Constitutional Prejudice

From Universal Press Syndicate [printed verbatim from fax]
For Immediate Release

Taken from the *Jospeh Sobran Column* by Joseph Sobran. Dist. by UNIVERSAL PRESS SYNDICATE. Reprinted with permission. All rights reserved.

WASHINGTON—Gosh! My one-man campaign to revive the 10th Amendment seems to be paying off! All over the nation, Americans are discovering the part of their constitutional heritage liberals hoped they wouldn't find out about.

Nancy Roman reports in the *Washington Times* that the forgotten 10th is now being invoked all over the place. It's being cited by States rejecting federal orders (known as, "unfounded mandates") to clean up their water and air, hire more police, jail illegal aliens—and to bear the costs themselves; by law enforcement officers who refuse to do background checks on gun purchasers, as demanded by the (unconstitutional) Brady Bill; by various champions of both states' and individuals' rights.

Colorado, followed by other states, is suing the federal government to "cease and desist" issuing unfounded mandates. Jim Abbott, chairman of the state's 10th Amendment Committee, notes that under the historical understanding of the *Constitution*, the federal government has no power to create departments of Health and Human Services, Labor, Transportation, Energy, Education, and Commerce, or the Environmental Protection Agency, the Food and Drug Administration, the Federal Communications Commission, and the Occupational Safety and Health Administration, to name a few of the many federal regulatory agencies.

The 10th is usually thought of as the states' rights amendment, but it's more than that. It says simply: "The powers not delegated to the United States by the *Constitution*, nor prohibited by it to the states, are reserved to the states respectively, or to the people." Put otherwise, "We the People" have "delegated" certain powers to "the United States" (i.e., the federal government). These powers are listed in the *Constitution*. And any powers not listed remain with the separate states or with Us the People.

There was a good reason for this amendment. Many of those who hesitated to ratify the *Constitution* didn't feel that the powers it conferred were tyrannical; but they feared that if the federal government had those powers, it would also be strong enough to claim and exert powers that hadn't been conferred—and at that point nothing would be able to stop it from taking all the powers it wanted. So the 10th nailed down the point that the people

were granting the federal government only those powers mentioned in the *Constitution*, and no others.

You can see this point more clearly by contrasting the 10th Amendment with its companion, the Ninth Amendment: "The enumeration in the *Constitution* of certain rights shall not be construed to deny or disparage others retained by the people." Put otherwise, the *Constitution* does not attempt to list all the people's rights, but it does list all the federal government's powers. There is thus a constitutional prejudice in favor of rights retained by the people, but against any new power claimed by the federal government.

Today, the operative prejudice is just the reverse. We think we don't have a right unless it's listed in the *Constitution*, but we assume that the federal government can claim just about any unlisted power it wants to. If the framers found out about this state of affairs, they'd reach for the smelling salts.

How did the central principle of the *Constitution* get stood on it's head? The chief villain was Franklin Roosevelt. His New Deal didn't just "expand" the power of the federal government, as is usually said; it destroyed the very principal of resistance to federal expansion. From then on, the federal government has had the power of writing its own *Constitution*.

In 1940 Roosevelt's rubber-stamp Supreme Court declared the 10th Amendment a mere "truism", of no force or effect. And since then the court has never struck down a single major power-grab by the federal government, while it has extirpated hundreds of state laws. The court has "expanded"—distorted and inflated, actually—the First, Fourth, Fifth, Eighth, Ninth and 14th amendments (not to mention the interstate commerce clause), but never the 10th or, interestingly, the Second. On the contrary, these two amendments have been contracted almost to nothingness. They seem to have no penumbral emanations.

By this selective expansion and contraction of the *Bill of Rights*, the federal government has redistributed rights and powers in its own favor. We the People may yet have something to say about that.



"This is top-secret stuff, Winston. You're going to have to eat this tablecloth!"

Grandma's Trump Card To Hopi Nation Plight

FAX HARD COPY

To: CONTACT INC. NEWS

RESPONSE TO FRONT PAGE STORY: "HOPI NATION CRIES OUT"

From: A CHEROKEE and a SIOUX, "FIRST AMERICANS" and "AMERICANS FIRST"

WE are passing on the "LOGS" of informations to you our brothers.

We call you brothers, as we are all brothers in this nation, and we must all bond together with our KNOWLEDGE and use our KNOWLEDGE, and THE RESOLVED ACTS OF CONGRESS which protect us WHEN WE USE OUR KNOWLEDGE from those who DEFY "ALL LAWS", "ALL TREATIES", "ALL ORDINANCES", "ALL ARTICLES OF CONFEDERATION", "ALL BILLS OF RIGHTS", "ALL ACTS OF CONGRESS RESOLVED", and try to take that which is NOT THEIRS TO TAKE, by EXCEEDING their VESTED POWERS.

We are affixing 35+ pages [on file at CONTACT office] of RECORDED, RESOLVED ACTS OF CONGRESS, THE ANTECEDENTS TO ARTICLE VI OF THE CONSTITUTION OF THE UNITED STATES OF AMERICA; IN THESE ARE CONTAINED "YOUR RIGHTS". Including "Subject to the Constitutional Laws" Article VI provisions.

NOTICE: "RUSSELL HERMAN'S FAMILY WAS GIVEN THE WATER RIGHTS WEST OF THE OHIO BY PRESIDENTIAL GRANT, COURTESY OF PRESIDENT GRANT". It's a matter of Congressional Record. Neither Russell Herman nor his family, nor his heirs have given any authorization to take ANY WATER from ANY SOURCE "granted" by President Grant, from "ANY INDIAN and/or ANY INDIAN NATION". (period)

Read these documents carefully, as they contain your RIGHTS to STOP unauthorized interference and ANY ACT IN BAD FAITH AGAINST AMERICAN INDIANS AND THEIR LANDS AND NATURAL RESOURCES.

If we can be of further assistance let us know.

/s/ GRANDMA (a Cherokee) and GRANDPA (a Sioux)

GET WITH THE INTENDED PROGRAM

TO: CONTACT, Inc. News
Rick Martin

July 23, 1994

Dear Rick and Readers,

I fear I have overburdened the CONTACT's FAX by sending through so many of our ORIGINAL LAWS, on their fax today, July 23rd, 1994. It is ever-more-so important that these ORIGINAL LAWS Compacts, Treaties, Bills of Rights, Territorial Ordinances, Alliances, Debts and Engagements, Contracts and other legal provisions as set forth by the founding fathers, intending a ROAD MAP be set forth for all to follow who came after them, seeking the truths of this great nation.

This great nation at first was "Plantations", by "Charters" from King James, etc., one being the Plymouth Plantation of Massachusetts.

In order to "find our true laws", and to determine what went wrong—in order to rectify the wrong, we must go back to the beginning and "determine what made it work in the first instances of successful historic values, determined by our COMMON LAWS, guaranteeing our Rights, our Liberties, our Freedoms and our Rights as FREEDMEN to be SOVEREIGN over our destinies, lives, possessions and other in like kind...."

We must take into consideration:

(a) the originals were: (1) New York, (2) New Hampshire, (3) Massachusetts, (4) Connecticut, (5) Pennsylvania, (6) New Jersey, (7) Delaware, (8) Virginia, (9) North Carolina, (10) South Carolina and (11) Georgia.

(b) The laws of these ORIGINALS bounded the OHIO River to an approximation of the point where the great Mississippi and the OHIO join at Cairo, Illinois (VIRGINIA at that time). In this instance, the VIRGINIA BILL OF RIGHTS are pertaining to the Constitutional provisions of Article VI of the great and inestimable CONSTITUTION of the United States, and all of these ORIGINAL STATES did have ORIGINAL BILLS OF RIGHTS, adhered to in ARTICLE VI, once again.

(c) Our great CONSTITUTION did not begin and end on July 4th, 1776...it adhered to its "antecedents in its body being the great and inestimable CONSTITUTION's Article VI." It is as powerful in 1994 as it was intended to be in 1776 et seq. as mandated, scribed, penned, resolved, enacted...by the "antecedents" and/or parents of the CONSTITUTION if you please.

If you don't have a ROAD MAP, then you can't tell where you are going, and how you got there.

P.S. "I" will try to provision you with the maps so you can understand.

/s/ GRANDMA

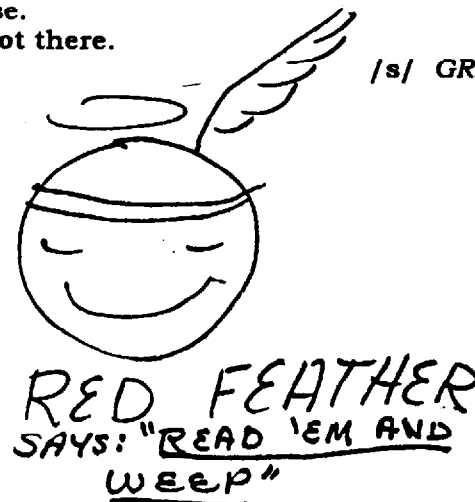
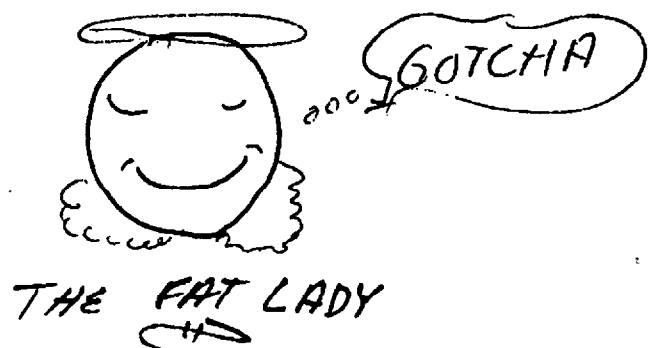

Grandma Sings Golden Oldies

THE FAT LADY SINGS "AT LAST"

CONTACT, Inc. News
July 20, 1994

REPETITION, REPETITION, REPETITION
(If at first they do not succeed, its the same
old %\$#@ over and over again)

Dear Rick and Readers,

Just had to comment on your cartoon in the latest issue of CONTACT: "History Department closed FOR RE-WRITING". This struck me as "funny" as they never seem to learn from their mistakes; they just try and try and try.

I, sometime ago, purchased a book on the HISTORICAL EVENTS OF THE NINETEENTH CENTURY and, believe it or not, it is just like sitting down and reading the daily newspaper of today—same old stuff, same old players, same nations. We didn't have a FEDERAL RESERVE, but players were the same as the players in the FEDERAL RESERVE.

Bosnia, Herzegovina, Serbia were at it, had made a peace and alliance for mutual common defense, we were having some intermeddling into our own "internal affairs", a war was about to ensue (the Civil War), Russia had her problems, England was about, all about, causing trouble here and there; she and her cousins could not agree on anything. South Africa was in a turmoil, the Boer War was ongoing; intermeddling in the South American Nations/Republics had caused WARS down there. It's almost as though they have a TIME SCHEDULE, and these things must take a turn in the events, one by one, and it is the same old thing all over again.

The United States of America had her own POLITICAL CORRUPTION; they were doing their old thing, selling off GOLD TREASURY BONDS, then cancelling them. Fraud after fraud was committed against the people.

Then they finally decided they were about to get their "fannys kicked" by the people as corruption was rampant in the administrations, so they entered into a contract with the Morgan Syndicate to shore up the economy.

The Morgan Syndicate loaned money out to the U.S.A., and made certain the shenanigans would not be pulled on them; they had a CONTRACT. Unfortunately, CONTRACTS do not do so well when the PARTIES to the CONTRACT decide to take a TRIP ON THE TITANIC.

Then, along comes those "three" people, who, when Congress is out of session, take it upon themselves to PASS the FEDERAL RESERVE ACT. The Constitution says, "TWO THIRDS OF THE CONGRESS 'ASSEMBLED' AND TWO THIRDS OF THE SENATE 'ASSEMBLED' must bein session before ANY

LAW can be MADE"! How in the Hell did this FEDERAL RESERVE ACT get passed? OR better still, who got paid to pass the damned thing?!!

Historically, since the FEDERAL RESERVE "BUNCH" have been in power, every time the AMERICAN PEOPLE begin to get their heads above the water, UP GOES THE INTEREST RATE, and UP GO THE TAXES!

With the interest rate and the tax rates going hither, thither and yon, Americans do not have a CHANCE IN HELL of ever rebuilding this nation, UNDER FREE ENTERPRISE. But, nation after nation, anywhere else on the globe, can get rebuilt...ON AMERICAN MONEY!

AMERICANS keep losing their homes, lands, properties, jobs—and each of these have been used by the Administrations and the Federal Reserve as ASSETS FOR THE FULL FAITH AND CREDIT of the United States of America. In other words, AMERICA AND AMERICANS have been TAKEN OVER BY FOREIGN ENTITIES who act under a set of Corporations which are foreign-owned and foreign-held. The WATER RIGHTS are FOREIGN OWNED, most of the FOOD PRODUCTION, 92% to be exact, IS FOREIGN OWNED, 100% of the MONEY IN AMERICA IS FOREIGN OWNED!!!!

"What !?" you say? (1) CARGILL controls 92% of the FOOD PRODUCTION, (2) THE "ROSE SYNDICATE" of Scotland (England) also known as your local MUNICIPAL WATER DISTRICT owns your DRINKING WATER, (3) THE FEDERAL RESERVE CONTROLS YOUR MONEY, 100%.

A very strong observation, and suggestion, with all these entities being FOREIGN OWNED, and this GUN CONTROL measure is ongoing: IF I were the John and Jane Does of America, I WOULD TAKE A GOOD LOOK AT BOSNIA, SOMALIA, RWANDA and other places that are being systematically WIPED OUT, and they STARVE TO DEATH, and ARE PUT ON FORCED MARCHES, DENIED EVEN WATER, and THEY CAN NOT DEFEND THEMSELVES; they have NO COMMON DEFENSE as identified in the Constitutional SECOND AMENDMENT!

And YOU THINK YOURSELVES TO BE A "FREE AMERICA"!??

All that RUSSIAN- and GERMAN-MADE MILITARY EQUIPMENT STATIONED ALL OVER THE UNITED STATES is not here FOR OUR HEALTH!

NEITHER ARE THOSE "CONCENTRATION CAMPS"!

You allegedly astute Americans had better use your heads for something other than a HAT RACK because WE HAVE A BUNCH OF TROUBLE LOOKING DOWN ITS BARRELS AT US, RIGHT HERE ON OUR OWN DOORSTEPS, and YOU SIT LIKE OSTRICHES WITH YOUR

HEADS IN THE SAND? I think, if it were me, I would quit looking at all those "string bikinis" and take a good look at what is really going on in America!

And you MACHO MEN keep saying, "I AM TOO MACHO TO ALLOW ANYTHING TO HAPPEN". "MACHO", in its true sense, means "JACKASS OR MULE".

Take a look at our LATEST AND RECENT CONFLICTS. More Americans are killed by FRIENDLY FIRE than from the alleged enemies (with machetes, spears, and guns that are out of ammunition). CLEARLY, Americans are their OWN WORST ENEMY.

NOW, about HAITI: "Democracy" is truly at work because THE PRESIDENT of the United States discovered there are \$35 BILLION in American TREASURY SILVER CERTIFICATES in the Commercial Banque de Haiti. It's been down there for years, SYNDICATE OWNED, represented by the BANK'S PRESIDENT, RICHARD KNUBANY.

That is probably WORTH A WAR, but on a personal note, there is a CONTRACT on that \$35 Billion American Treasury Silver Certificates. Did you know that, MR. CLINTON!? AND, it has TWO MORE YEARS TO GO!

The TRUE STUFF that WARS ARE MADE OF, is OIL (Kuwait), GOLD (Africa), Silver (Silver TREASURY NOTES) in HAITI.

The "FAT LADY" has the CONTRACT ON THE SILVER CERTIFICATES, MR. CLINTON, Mr. Bush, Mr. Baker, Mr. Bentsen et al.

Remember, George Bush used to say: "BUT THE FAT LADY HAS NOT SUNG YET, AND IT'S NOT OVER TILL THE FAT LADY SINGS".

THE "FAT LADY IS SINGING \$ AT LAST".

/s/ THE FAT LADY (Grandma)

P.S. By the way, boys: I ain't that stupid to keep all that info. in the U.S.A. You made some powerful enemies, when you shook their hands on the faith of America, and instead of them being able to take your WORD to the bank, you stole the BANK! Didn't your mommas tell you, "IT AIN'T NICE TO STEAL"?

/s/ THE FAT LADY



Ronn Jackson Answers More Questions From Readers

Bulletins #13 & 14

by Ronn Jackson

Before I get into answering specific questions, I would like to relate to a little experiment that I conducted. I should preempt my words with the motivation that prompted the experiment. With personally receiving over 35,000 pieces of mail, naturally there is a repetition on most every subject, but on what I would estimate, twenty times, I have received requests about history and/or a period of time going back to and including events that have been recorded by one means or another. In other words, what you and I have been taught at one level or another, by one medium or another.

If you stop and think, history goes back to the pyramids and the building of them. Why do you suppose that nothing exists prior to that time, approximately 5,000 years ago? Sure, there are bits and pieces that exist but nothing of a real definite nature. It is almost as if civilization started, in our plane of reference, about 2,100 B.C. (give or take a few hundred years).

There are various scientific explanations about how we, as a species, evolved, but they are all theories based on other information and if you were to ask for written records, again there are bits and pieces and all you will receive is an opinion of someone based on other information that is known to that someone. In other words, nothing in writing exists that is documented prior to a short time prior to the building of the pyramids. Scientifically, we as a species are much older, we believe, but why does not there exist proof. Okay, there are stories about a Queen of Egypt who was not satisfied with history and had all that was recorded, destroyed. Again, this and other theories are pure speculation.

In a former writing, I made the statement to an individual, "Mankind has reached our current level of knowledge, twice before." Six days later, I received another letter asking me to explain my statement. I still haven't answered the second letter and, realizing I was procrastinating, I asked another 10 people the same question; hence, the experiment.

After explaining what I was asking, almost uniformly, the answer was the same. Ancient Egypt was the beginning of what all those had been taught and knew of. Oh, there were questions about the dinosaurs and the Bible and I politely informed them that I was asking what they knew, with a reasonable amount of certainty; what all had been told or taught about mankind and what they had received for documentation. In every instance, all said the very same thing.

I then asked two Hispanic people, one born in "Mexico" and one born in "Honduras". I have made two conclusions from my experiment: First, everyone has a mental block and can only relate to that specific time frame (up to 5,000 years ago). And two, no one can or

will admit to mankind being in or around more than 5,000 years and cannot explain it, nor will they even try unless prompted. Both Hispanics were educated in their own countries and were taught the same thing, in their language.

So that you understand what I was saying in that letter to the other reader, I am going to give you certain details and I will let you and historians decide what you want to do with it.

Civilization obtained its most advanced level as compared to what we have now, about 80,000 years ago. One of the locations is what we now refer to as "Atlantis". Selected parts of that civilization advanced to their next level of consciousness. There were several other segments and like levels of advancement, who also "moved on" and the remnants are what we have now, us, as in our current plane of reference. About 65,000 years ago, there took place an adjustment in our globe which can be best explained as a settlement in the land area and which changed the face of the Earth. In other words, Mother Earth, in her natural progression of aging, settled, and changed to what we now know as the configuration of the seven continents. If any of you are curious, what was referred to as "Atlantis" can be found in a direct westerly line from the southernmost tip of "Portugal" and below 17,000 feet of water. Although, there no longer exists a globe or circle encom-

passing the city, it is still intact and is under about 10 feet of sediment.

Mankind first developed to its next level of advancement approximately 450,000 years ago, in our current plane of reference in physical time.

These details were given to me by a current member of "MJ-12". I have drawn the following conclusions based on my current level of knowledge and consciousness.

When I first read *Childhood's End* by Arthur C. Clarke, about 25-30 years ago, I knew the book was and is a prophecy.

Mankind took about 600,000 years to develop to its next level the first time, and 385,000 years to develop into its second advancement. Since I now know the meaning of the date of April 12, 2011, the third time will have taken, since this is 1994, a little over 82,000 years. This will be the beginning and you now can fill in some of the gaps of history.

1. "Mike" from Naples, Florida asks: "What is your opinion of North Korea?" The entire North Korea situation is being very carefully orchestrated by our Government. This is how Government perpetuates itself by fabricating a mythical crisis. As to "China" joining forces with North Korea, they are Communist countries and are together in a manner of speaking; however, since Capitalism has been introduced to the "Peoples' Republic," war with this country is questionable.

2. "Mary Jean" from Grand Junction, Colorado asks: "What is your opinion of the 10th Amendment initiative from Colorado?" Several states have a similar initiative on the agenda. The Government won't pay any attention until several states adapt the same policy. Make no mistake: Government is aware of your State's initiative and will, "tread water soon."

3. "John C." from Bedford, Indiana asks:

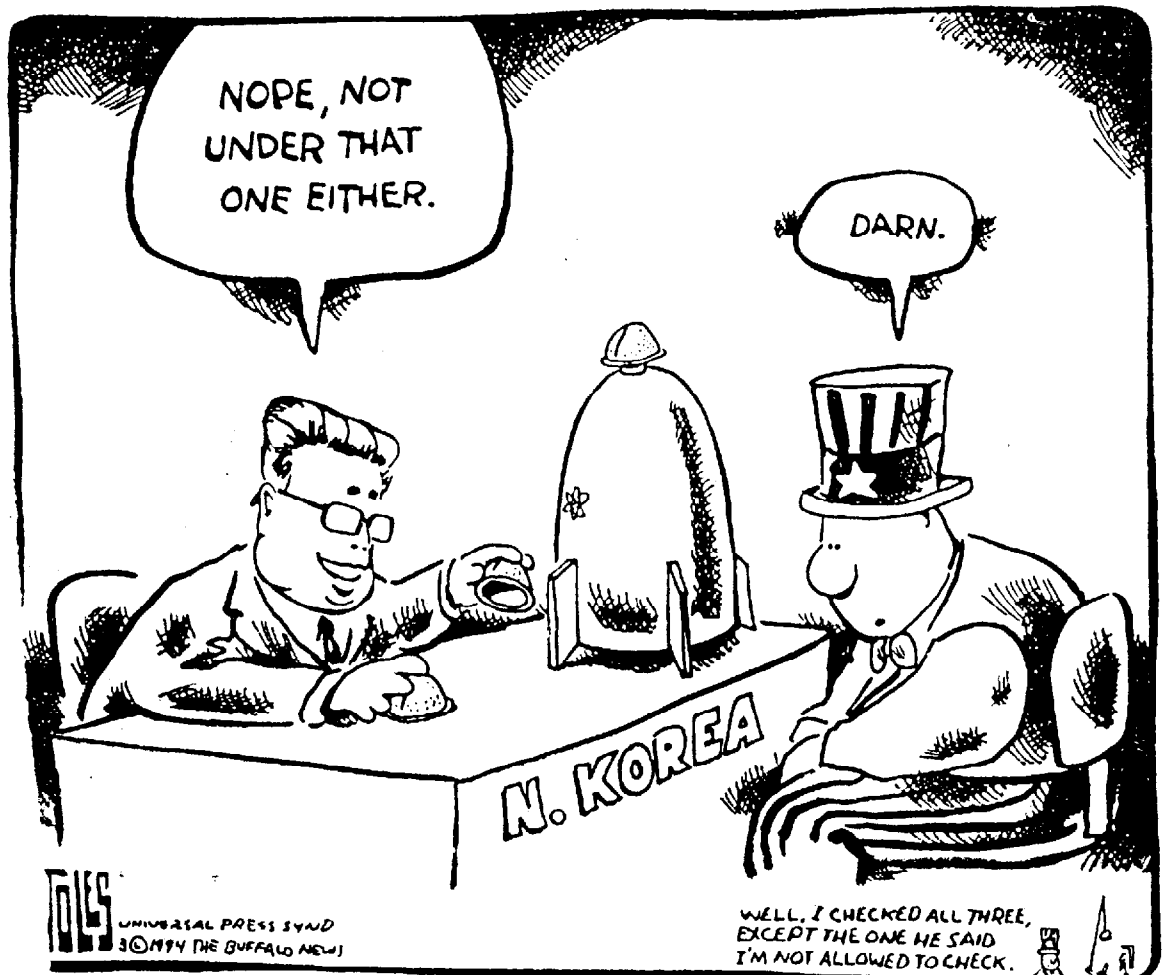

"What is your opinion of the, 'O.J. Simpson' fiasco?" To be perfectly honest with you, had Mr. Simpson used the gun he was supposed to have had to his head in the chase scene, I would have had a lot more respect for him. As it is now, I am confident in the jury that will judge him. Never sell your fellow citizens short.

4. "Leon" from Birmingham, Michigan asks: "Do you drink wine and do you have a preference?" Yes, I enjoy wine and with dinner; I prefer a Cabernet Sauvignon; preferably, "Robert Mondalvi" 1979.

5. "John" from Thousand Oaks, California asks: "Since you seem to know something about finance, what is 'QVC' doing attempting to merge with CBS?" That's the easiest question I had all day. Mr. Diller is not really trying to merge with the network, he is raising the price of "QVC" stock. It is a ploy only and he is out of his league. CBS is "old" and "big-time" money; that doesn't mean Mr. Diller cannot obtain that status.

6. "John L." from Longmont, Colorado asks: "My personal computer has 2 megabytes of RAM. I've heard about Super-Computers having much more. Please explain how a 'CRAY XMP-XX' is configured." The last, "CRAY" Super-Computer that I worked with was a "XMP-48". Its core memory was 8 million, 64 bit words. Your computer as you described it is a 16-bit, emulating 32-bit architecture. If you were to compare your computer to that CRAY, it would take 1-1/2 million to equal its capabilities. Yours runs at 25 MHZ. The CRAY runs at 210 MHZ. You cannot work a Super-Computer with a keyboard. You need a front-end to operate a Super-Computer. (A Main-Frame.) Normally, it takes about 90 days to write software for a front-end of a Super-Computer. Yes, a CRAY can have (the model you asked about) up to 8 processors. You need special software for parallel processors.

7. "Mr. & Mrs. Marty H." of Boise, Idaho ask: "Do you have stocks that you would recommend?" Yes, I do, but I would tell you to buy gold first. If, after you keep some cash for a rainy day, I would say buy, "Hansen 'B' Warrants" and almost any gold or silver stock listed on the Big Board [*NY Stock Exchange*].

8. "Mason" from Baltimore, Maryland asks: "You mentioned Warren Christopher as being a part of the Committee. How can he be in Government?" Because he is. He is a very powerful man. He has a law office in Los Angeles with a branch in Washington, D.C. His Committee office is located on N.W. 16th Ave. in Washington, D.C. Yes, he is married. His family members are innocent victims. I think he is 73 or 74. His soft voice is deceiving. If he is replaced as Secretary of State, it will be because he wants to be. Bill Clinton was doing what he was told to do. I am afraid politics are not what you envision them to be.

9. "Karen & Charles" from Taos, New Mexico ask: "Explain the beginning of the judicial system. We are sure you know of it because of your lawsuit." I don't think anyone knows all about it. If you try to read anything that any attorney writes, you will be confused as it was intended for you to be. I will tell you what I know about the beginning of the Judicial. The authority used by the Judicial is the "Judicial Act of 1789". However, our Judicial is based on Admiralty Law which is the "Camanetti Act". If you were to lay the "Judicial Act of 1789" next to the "Camanetti Act", they are identical. **Neither one** was ratified by Con-

gress. The usurpations of your rights actually started before the *Constitution* was ratified in 1789. My last statement is not a new one. It was foreseen in *The Federalist Papers*.

10. "Steve" from San Mateo, California asks: "Why did you make the comments on dollars in the *CONTACT*?" I made comments on "Federal Reserve Notes". We no longer have dollars as a form of currency.

/s/ Ronn Jackson

Bulletin #14

1. "Macy & Ruth" from Louisville, Kentucky ask: "What are your views on, 'W.A. Annenberg'?" He is seeking to control your and my mind, and he doesn't try to hide it. He (his foundation) gives vast sums of money to "educational" programs. Many people in this country say he is a hero and a true American. What his money does is sell those who benefit from that money, into "bondage."

2. "Paul Shields" from Chicago, Illinois asks: "Why are you putting out all of this information?" If I don't, the Government will put you into a situation where they will tell you where to work and what to work at; what to eat and when; people from Germany will be assessing your taxes; people from South America will tell you where to travel; people from Japan will hold what money you may be entitled to, and so on. In other words, a faction of your elected officials want to rule the world and, if necessary, they will walk all over you to do so. This is called, "One World Order". If you would like an example of how this works, read George Orwell's *1984*.

3. "Mary" from Omaha, Nebraska asks: "I liked Ronald Reagan. You seem to have a low opinion of him. May I ask why?" I have a low opinion of all politicians, including Mr. Reagan. What you liked, from your letter, is his personality. He was likable, but being nice does not run this country, which was his job. One positive point of the former President was the "Grace Commission". Even the Government's own figures show that 35% of all Government spending is wasted. The Commission report was disregarded. [*See related story on p.40.*]

4. "Larry N." from Lakewood, Pennsylvania asks: "Our Senator, Arlen Specter, started his political career about 30 years ago. Do you know of his background?" Senator Specter, along with attorney David Belin of Des Moines, Iowa, was the co-Counsel for the "Warren Commission." Both were incredibly stupid as they both believed in Chief Justice Earl Warren, who headed up the investigation of the assassination of John F. Kennedy. His political career has spanned up to and including the present, which covers his last election to the Senate, in which he spent \$8.2 million to get elected to a job which pays \$142,500.00. I may be just an "old country boy", but I don't think you can explain any of his career to me. Just another one of the 720,000 members of the American Bar Association who is directly responsible for the decay of our once-great nation.

5. "Perry & Ruth" from Chico, California ask: "When did the Government start taking away our rights?" Almost the same time our *Constitution* was ratified, but history will show that the single most damaging act was right around the Civil War, around 1860, when the political representatives started inferring that

the "United States" and the "United States of America" had the same meaning. This fact will not be found in any history book. The source is found in *The United States Code* and by the decisions of the Judicial starting at that time. Did you know: "There are two United States"?

6. "Edward & Joan" from Phoenix, Arizona ask: "We still have the technology that made this Country what it is. Why are you so opposed to what our Government is doing?" Your question would take a thousand pages to answer. Continue to read *CONTACT* and you will receive truth. Our Government does not control itself. Only a few men & one woman does. They are maneuvering an extremely complacent society into a herd of sheep. While you pay your bills and feed your family, they have you believing, "Things are good." Things are not what you believe them to be. We have an unfunded currency, a military at its lowest level in many years, diminished buying power, and the most serious of problems is, "several manufactured 'crises'". You keep believing "Bill Clinton" and Congress and I only ask one thing of you: Please don't send me an invitation to the funeral of your family.

7. "Art B." from Las Vegas, Nevada states: "Mr. Jackson, I believe you to be a fraud." Thank you for your opinion, Mr. "B."

8. "Joyce" from Grafton, Massachusetts asks: "Can you give me any information on the 'Kennedy' family that has not been told? I am thinking of running for public office." Sorry Joyce, I don't deal in smut. There is enough information that is of public record to disqualify most people, that doesn't seem to affect the Kennedy family. The people in your state continue to re-elect Ted Kennedy. I'm not sure the constituency of your state wants honesty or integrity.

9. "James & Marlene" from Bay City, Michigan write: "We lost money in 'Continental Bank' in Chicago. There are many stories circulating about their problems. Can you enlighten us on what happened?" That bank was primarily a commercial bank and made several substantial loans to the same people that "BCCI" had for customers. Also, Federal Banking rules require that so much of each "FRN" go to developing nations, which recently has been written off as uncollectible bad debts. What you don't realize is that by Government imposing these and other such rules, they are actually taking your money and giving it away. Instead of Government as an entity taking the loss, you as an individual take the loss and that keeps Government with all that much more power. Government, or should I say, "FDIC" bailed out that bank just a few short years ago. Bank of America just acquired it. "A.P. Giannini was one of the original committee (C.O.U.P.E.S) members. (The founder of Bank of America.) **Surprise—surprise!! Wake-up America!!**

10. "Arthur L." of Miami, Florida asks: "Please explain more on 'FEMA'. My wife and I are still waiting for funds promised several months ago. Although Hatonn has spoken of them, why are they taking so long? Can we go to another agency to get assistance? The local representatives keep saying they are passing our requests on. Our savings are almost gone." I hope your claim is satisfied soon. "FEMA" will be the first Government bureaucracy to go. There are other ways of helping one another. We don't need Government.

Please watch for Bulletin #16. It is devoted to "FEMA".

/s/ Ronn Jackson

Insider Report

From INSIDER REPORT
column of *The New American*

Editor's note: The following article has been sent to us by Ronn Jackson with a request to "print this". The article as received was not complete, but we will print what we have. Please note, CONTACT is not permitted distribution at any Government facility on a regular subscription basis. Men were killed by "friendly fire" for having copies of CONTACT during the Gulf War, and several soldiers who began as regular readers in South Korea had papers confiscated and their lives were threatened if CONTACT continued. Basically an entire group of people, Government employees, who could make a difference, either are scared spitless or are simply not allowed to know about the paper.

Police State Update. *The New American* has received a copy of a "Combat Arms Survey" which was administered to Marines at the Twenty-nine Palms, California Marine base on May 10th. Attached to the survey was a letter from a young Marine, who explained: "Enclosed is a survey given to me and other Marines from different units on base that had participated in either Operations 'Just Cause,' 'Desert Storm,' or 'Restore Hope.' A Navy commander came before us and said he was working on his Master's Degree and he was writing a paper about giving up our military's sovereignty to the United Nations Secretary-General. Needless to say, I was shocked. I marked all of the questions 'strongly disagree' and turned in the survey. The Marine next to me just happened to grab two surveys as they were being passed out. He agreed to give [one] to me."

The survey posed a number of statements and asked the Marines to respond along a scale running from "strongly disagree" to "strongly agree". Among the statements contained in the survey were the following: "I feel the President of the United States has the authority to pass his responsibilities as Commander in Chief to the UN Secretary-General"; "I feel there is no conflict between my oath of office and serving as a UN soldier"; "I would be willing to volunteer for assignment to a U.S. combat unit under a UN commander"; "I would like UN member countries, including U.S., to give the UN all the soldiers necessary to maintain world peace"; "I would swear by the following code: 'I am a United Nations fighting person. I serve in the forces which maintain world peace and every nation's way of life. I am prepared to give my life in their defense.'"

The final statement posed a shocking scenario:

The U.S. Government declares a ban on the possession, sale, transportation, and transfer of all non-sporting firearms. A thirty (30) day amnesty period is permitted for these firearms to be turned over to the local authorities. At the end of this period, a number of citizen groups refuse to turn over their firearms. Consider the following statement: I would fire upon U.S. citizens who refuse or resist confiscation of firearms banned by the U.S. government.

It should be recalled that the "assault weap-

ons" ban was passed on May 5th—five days before this survey was administered. The Marine told *The New American* in a telephone interview that it was his impression that the survey "was just research for this [Navy] commander's degree," and he was not aware of similar surveys being administered at other facilities. The Marine also sent *The New American* a clipping from the base's weekly newspaper describing the March visit from several members of the Council on Foreign Relations. The CFR delegation received a high-profile tour of the facility's Combat Center.

There are other indications of an ominous change in America's military culture. According to a *St. Louis Post-Dispatch* story, *Parameters*, the journal of the Army War College, recently published an essay by Major Ralph Peters warning about the creation of a worldwide "warrior class" composed of "erratic primitives of shifting allegiances, habituated to violence, with no stake in civil order." According to Major Peters, among the groups which compose the "warrior class" are "genuine patriots". Peters writes that in dealing with patriots and other "primitives", the proper approach is "irresistible violence directed against the warlord and the warriors. You cannot bargain or compromise with warriors."

Clintonizing the Constitution. President

Clinton has offered two fascinating specimens of constitutional interpretation. The first statement came during MTV's *Enough is Enough* forum on April 19th: "...when we got organized as a country and we wrote a fairly radical Constitution with a radical *Bill of Rights*, giving a radical amount of individual freedom to Americans, it was assumed that the Americans who had that freedom would use it responsibly." However, said Mr. Clinton, in contemporary America "there's a lot of irresponsibility. And so a lot of people say there's too much personal freedom."

Mr. Clinton—the quintessence of personal responsibility—told his audience, "When personal freedom's being abused, you have to move to limit it. That's what we did in the announcement I made last weekend on the public housing projects, about how we're going to have weapon sweeps and *more things like that* to try to make people safer in their communities" (emphasis added). Mr. Clinton's reasoning is that because government had "given" people "a radical amount of freedom," the government could take away any amount of freedom it decided was excessive.

The same assumptions were displayed by Mr. Clinton during a May 2nd press conference intended to promote the "assault" weapons ban. Stated Mr. Clinton: "How can we walk away from this? Especially when this bill protects over 650 specific hunting weapons? I mean, I don't understand why the [gun] organizations aren't saying, 'well, hallelujah, this is the first federal explicit protection we ever had for the means of hunting.'" Once again, Mr. Clinton was saying that Americans possess only those liberties the state decides to give them.

Unconstitutional Procedures Exercised Against Ronn Jackson

July 15, 1994
RE: CV-N-93-401-DWH

Judge David Hagen
U.S. District Court
300 Booth St. #5003
Reno, NV 89509

Your Honor,

The Attorney General has instructed the legal officer of this institution to censor all of my legal mail. Is this your version of due process?

My purpose in writing you is that on August 5th, 1994, the pre-trial information on the above case is due. I have written "Yvonne Facchina" to conform with your order and all requests have been disregarded by the Attorney for the Federal Reserve.

As you are aware, patriots all over this country are watching this case and I can assure you our *Constitution* is going to be restored.

/s/

Ronald L. Jackson-33866
NNCC P.O. Box 7000-8A13-RMF
Carson City, NV 89702
Pro-Se Litigant

THE Committee Of 17

Editor's note: What you are about to read is the most important list of global controllers on the planet. Ronn Jackson has finally agreed to reveal the entire list of these names and has done so exclusively to CONTACT. Pay attention, now, as you read this list of USURPERS who play THE most profound controlling role in our day-to-day lives, in ways none of us can yet quite imagine.

- A1 - WALT ROSTOW**
- A2 - STEVEN M. WOLF**
- A3 - WILLIAM T. JONES**
- A4 - NORMAN MAILER**
- A5 - WARREN CHRISOPHER**
- A6 - SIR JAMES GOLDSMITH**
- A7 - JACQUES SANTER**
- A8 - HUBERTUS VON GRUENBERG**
- A9 - JUAN CARLOS**
- A10 - ALBERTO FUJIMORE**
- A11 - EDWARD SHEVARDNADZE**
- A12 - JOHN MCFARLANE**
- A13 - JEAN CHRETIEN**
- A14 - TOMIICHI MURAYAMA**
- A15 - BARBARA JORDAN**
- A16 - ALEXANDER SOLZHENITSYN**
- A17 - RONN JACKSON**

NOTES:

- A2 - Admiral Byrd, in our frame of reference he is known as Steven M. Wolf, CEO United Airlines.
- A3 - Henry Ford, in our frame of reference he is known as William T. Jones, President National Energy Group.
- A4 - Adolf Hitler (up to the age of 28 years), in our frame of reference he is known as Norman Mailer.
- A5 - Warren Christopher, Secretary of State.
- A6 - Bertrand Russell, in our frame of reference he is known as Sir James Goldsmith (active trader in the gold market).
- A7 - Jacques Santer, Prime Minister of Luxembourg.
- A8 - Hubertus Von Gruenberg, Continental Tire Company AG, Germany.
- A9 - Sir Isaac Newton, in our frame of reference he is known as Juan Carlos, Royal Family of Spain.
- A10 - Alberto Fujimore, President of Peru.
- A12 - John McFarlane, British banker from Hong Kong.
- A13 - Jean Chretien, Prime Minister of Canada.
- A14 - Tomiichi Murayama, the new Prime Minister of Japan.
- A15 - Barbara Jordan, with the LBJ Law Center.

The Death Of Camelot

By Ronn Jackson

Organizational Chart #4

[Editor's note: We have been informed by Ronn that this chart holds THE key for many missing aspects to the "shadow government" organizational puzzle. When viewed along with the ongoing USURPERS material on Lyndon Johnson and others, combined with last week's extremely important Committee drug operations charts on pages 46-52, plus the now-complete list of Committee players on page 38 of this issue—the pieces begin to fall into place. Do not be concerned if, for you, they don't. To those who need to know, this, we are told, will have great meaning.]

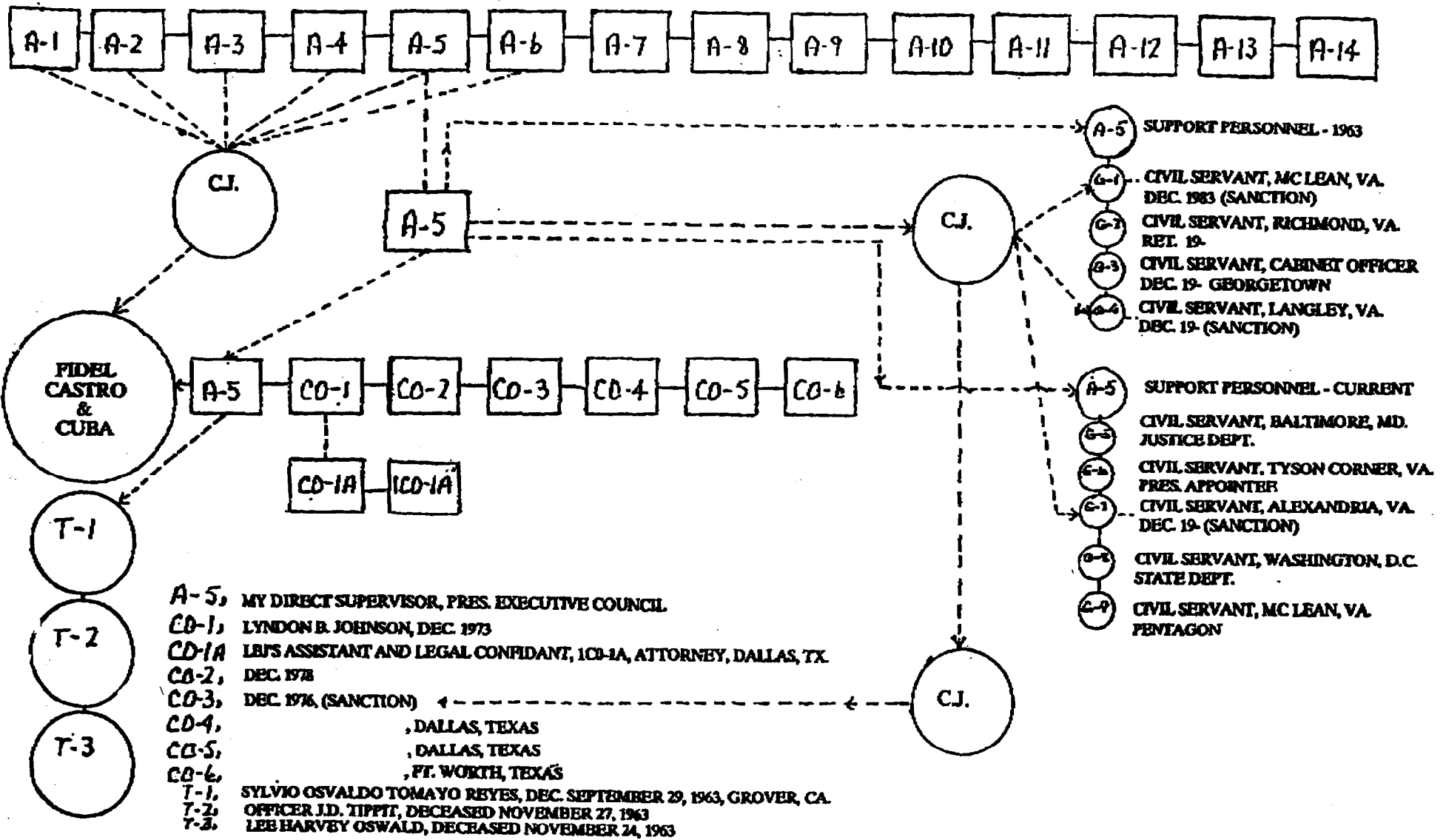

COMMITTEE OF 17

- | | |
|-----------------------------|------------------------------|
| A1 - WALT ROSTOW | A9 - JUAN CARLOS |
| A2 - STEVEN M. WOLF | A10 - ALBERTO FUJIMORE |
| A3 - WILLIAM T. JONES | A11 - EDWARD SHEVARDNADZE |
| A4 - NORMAN MAILER | A12 - JOHN MCFARLANE |
| A5 - WARREN CHRISOPHER | A13 - JEAN CHRETIEN |
| A6 - SIR JAMES GOLDSMITH | A14 - TOMIICHI MURAYAMA |
| A7 - JACQUES SANTER | A15 - BARBARA JORDAN |
| A8 - HUBERTUS VON GRUENBERG | A16 - ALEXANDER SOLZHENITSYN |
| | A17 - RONN JACKSON |

CAGW Honors Grace Caucus

[Editor's note: See Ronn Jackson's answer to question #3 on p. 36 for more on this atypical endeavor by politicians.]

By Joe Winkelmann

CAGW Co-chairmen J. Peter Grace and Jack Anderson honored 197 members of Congress who are members of the Congressional Grace Caucus at an awards reception March 15.

Caucus Co-chairmen Sens. Herb Kohl (D-Wisc.) and Hank Brown (R-Colo.) and Reps. Chris Cox (R-Calif.) and Frank Pallone (D-N.J.) exhorted their colleagues to continue their bipartisan effort, which has characterized Grace Caucus activity, to promote legislation and other action to eliminate waste, inefficiency, and mismanagement in the federal budget.

Grace thanked the Caucus members for their dedication to the taxpayer. Grace said, "It's always been an American tradition that your children live better than you

did." He added, "Unfortunately, if we don't balance this budget in the next five to ten years, we will no longer pass on a higher standard of living to the next generation by the year 2015."

Rep. Pallone stated that bipartisanship is key to cutting government waste effectively. Pallone said he hoped the event would be "a kickoff for [waste-cutting] activities on the part of the Caucus over the next few months of this Congress."

Rep. Cox noted that "total spending for FY 1994 is more than the federal government spent during the entirety of five years from 1969 to 1973." Cox added, "There's no question that we've got to put a lid on it."

Sen. Brown remarked that

Americans recognize the need for a long-term plan for our budget. "The deficit threatens to swallow up the entire future of our country." Brown summed up, "Peter Grace's leadership on this issue over the years has served to alert the country of the problem of government waste and could turn around the very bleak future of our country."

Since its inception eight years ago, the Congressional Grace Caucus has worked with CAGW as a resource to help enact some \$250 billion in federal budget savings.

Grace and CAGW President Thomas A. Schatz presented certificates to Caucus members citing their "dedication to American taxpayers."

Schatz noted that this year more than 50 members of Congress have

joined the Congressional Grace Caucus, increasing membership by more than a third and establishing a new record.

Sen. Kohl, citing his bipartisan work with Senate Co-chairman Brown, called for shared sacrifice to achieve success.

"Last fall, Sen. Brown and I and others were involved in crafting a bipartisan plan that would have made almost \$100 billion in real spending cuts. That process was not easy. All of us [who were] engaged had to accept some cuts we did not fully support and forgo some cuts we supported strongly.

"But in the end, we agreed on a package, and we defended that package on the Senate floor," Sen. Kohl said.

SENATE GRACE CAUCUS



Howell Heflin (D-Ala.)



Frank H. Murkowski (R-Alaska)



Dennis DeConcini (D-Ariz.)

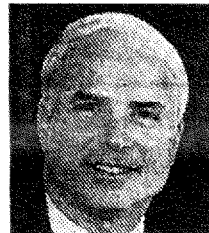

John McCain (R-Ariz.)



Hank Brown (R-Colo.)
Co-chairman



Ben Nighthorse Campbell (D-Colo.)



William V. Roth, Jr. (R-Del.)



Bob Graham (D-Fla.)



Connie Mack (R-Fla.)



Sam Nunn (D-Ga.)



Larry E. Craig (R-Idaho)



Paul Simon (D-Ill.)



Charles E. Grassley (R-Iowa)



John F. Kerry (D-Mass.)



Conrad Burns (R-Mo.)



Harry Reid (D-Nev.)



Robert C. Smith (R-N.H.)



Bill Bradley (D-N.J.)



Jesse A. Helms (R-N.C.)



Byron L. Dorgan (D-N.D.)



Don Nickles (R-Okla.)



Arlen Specter (R-Pa.)



John H. Chafee (R-R.I.)



Ernest F. Hollings (D-S.C.)



Strom Thurmond (R-S.C.)



Thomas A. Daschle (D-S.D.)



Phil Gramm (R-Tex.)



Kay Bailey Hutchison (R-Tex.)



Orrin G. Hatch (R-Utah)



James M. Jeffords (R-Vt.)

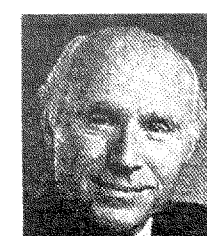

Herb Kohl (D-Wisc.)
Co-chairman



Alan K. Simpson (R-Wyo.)

HOUSE GRACE CAUCUS

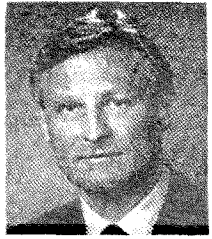

Spencer Bachus
(R-Ala.)



Sonny Callahan
(R-Ala.)



Jim Kolbe
(R-Ariz.)



Jon Kyl
(R-Ariz.)



Bob Stump
(R-Ariz.)



Tim Hutchinson
(R-Ark.)



Bill Baker
(R-Calif.)



Anthony C.
Beilenson
(D-Calif.)



Ken Calvert
(R-Calif.)

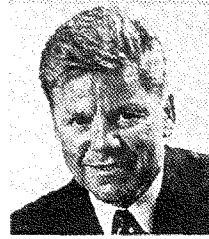

Gary A. Condit
(D-Calif.)



Christopher Cox
(R-Calif.)
Co-chairman



Randy (Duke)
Cunningham
(R-Calif.)

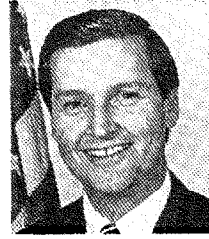

John T. Doolittle
(R-Calif.)



Robert K. Dornan
(R-Calif.)



David Dreier
(R-Calif.)



Elton Gallegly
(R-Calif.)



Jane Harman
(D-Calif.)



Wally Herger
(R-Calif.)



Steve Horn
(R-Calif.)



Duncan Hunter
(R-Calif.)



Jay Kim
(R-Calif.)



Jerry Lewis
(R-Calif.)



Howard P. (Buck)
McKeon
(R-Calif.)



Carlos J. Moorhead
(R-Calif.)



Ron Packard
(R-Colo.)



Richard Pombo
(R-Calif.)



Dana Rohrabacher
(R-Calif.)

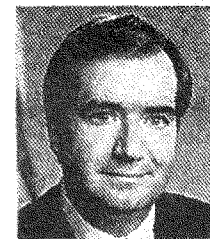

Ed Royce
(R-Calif.)



Bill Thomas
(R-Calif.)

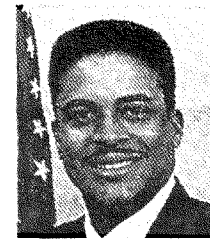

Walter R. Tucker III
(D-Calif.)



Wayne Allard
(R-Colo.)

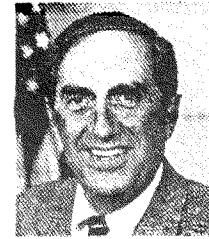

Joel Hefley
(R-Colo.)



Dan Schaefer
(R-Colo.)



Patricia Schroeder
(D-Colo.)



Nancy L. Johnson
(R-Conn.)



Christopher Shays
(R-Conn.)



Michael Bilirakis
(R-Fla.)



Tillie Fowler
(R-Fla.)



Porter J. Goss
(R-Fla.)



Earl Hutto
(D-Fla.)



Tom Lewis
(R-Fla.)



Bill McCollum
(R-Fla.)



Dan Miller
(R-Fla.)



Ileana Ros-Lehtinen
(R-Fla.)



E. Clay Shaw, Jr.
(R-Fla.)



George (Buddy)
Darden
(D-Ga.)



Nathan Deal
(D-Ga.)



Newt Gingrich
(R-Ga.)



Don Johnson
(D-Ga.)



John Linder
(R-Ga.)



J. Roy Rowland
(D-Ga.)



Michael D. Crapo
(R-Idaho)



Jerry F. Costello
(D-Ill.)

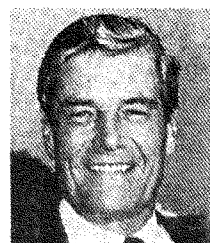

Philip M. Crane
(R-Ill.)



Richard J. Durbin
(D-Ill.)



Thomas W. Ewing
(R-Ill.)



Harris W. Fawell
(R-Ill.)



J. Dennis Hastert
(R-Ill.)



Henry J. Hyde
(R-Ill.)



Donald Manzullo
(R-Ill.)



John Edward Porter
(R-Ill.)



Glenn Poshard
(D-Ill.)



Dan Burton
(R-Ind.)



Jill L. Long
(D-Ind.)



Jim Lightfoot
(R-Iowa)



Jan Meyers
(R-Kans.)



Richard H. Baker
(R-La.)



James A. Hayes
(D-La.)



Bob Livingston
(R-La.)



Jim McCreery
(R-La.)



Olympia J. Snowe
(R-Maine)



Roscoe G. Bartlett
(R-Md.)



Peter I. Blute
(R-Mass.)



Peter G. Torkildsen
(R-Mass.)



Dave Camp
(R-Mich.)



Bob Carr
(D-Mich.)



Peter Hoekstra
(R-Mich.)



Joseph Knollenberg
(R-Mich.)



Bart Stupak
(D-Mich.)



Fred Upton
(R-Mich.)



Rod Grams
(R-Minn.)

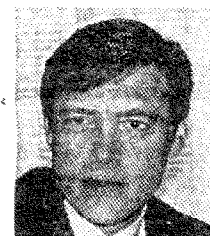

Timothy J. Penny
(D-Minn.)



Jim Ramstad
(R-Minn.)



Pat Danner
(D-Mo.)



Bill Emerson
(R-Mo.)

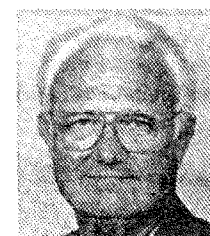

Mel Hancock
(R-Mo.)



James M. Talent
(R-Mo.)



Harold L. Volkmer
(D-Mo.)



Barbara F.
Vucanovich
(R-Nev.)



Bill Zeliff
(R-N.H.)



Bob Franks
(R-N.J.)



Dean A. Gallo
(R-N.J.)



William J. Hughes
(D-N.J.)



Frank Pallone, Jr.
(D-N.J.)
Co-chairman



Dick Zimmer
(R-N.J.)



Bill Richardson
(D-N.M.)



Steven H. Schiff
(R-N.M.)



Joe Skeen
(R-N.M.)



Hamilton Fish Jr.
(R-N.Y.)



Amo Houghton
(R-N.Y.)



Peter T. King
(R-N.Y.)



David A. Levy
(R-N.Y.)



Bill Paxon
(R-N.Y.)



Jack Quinn
(R-N.Y.)



Louise M. Slaughter
(D-N.Y.)



James T. Walsh
(R-N.Y.)



Cass Ballenger
(R-N.C.)



Howard Coble
(R-N.C.)



J. Alex McMillan
(R-N.C.)



Stephen L. Neal
(D-N.C.)



Sherrod Brown
(D-Ohio)



Eric D. Fingerhut
(D-Ohio)



Martin Hoke
(R-Ohio)



Marcy Kaptur
(D-Ohio)



John R. Kasich
(R-Ohio)



David Mann
(D-Ohio)



Michael G. Oxley
(R-Ohio)



Rob Portman
(R-Ohio)



Deborah Pryce
(R-Ohio)



James M. Inhofe
(R-Okla.)



Ernest Jim Istook
(R-Okla.)



Robert F. Smith
(R-Oreg.)



William F. Clinger
Jr. (R-Pa.)



George W. Gekas
(R-Pa.)



James C.
Greenwood (R-Pa.)



Paul E. Kanjorski
(D-Pa.)



Thomas J. Ridge
(R-Pa.)



Rick Santorum
(R-Pa.)



Bud Shuster
(R-Pa.)



Robert S. Walker
(R-Pa.)



Curt Weldon
(R-Pa.)



Ronald K. Machtley
(R-R.I.)



Arthur Ravenel, Jr.
(R-S.C.)



Floyd Spence
(R-S.C.)



John J. Duncan, Jr.
(R-Tenn.)



Bart Gordon
(D-Tenn.)



James H. (Jimmy)
Quillen (R-Tenn.)



Don Sundquist
(R-Tenn.)



Michael A. Andrews
(D-Tex.)



Dick Armey
(R-Tex.)



Joe Barton
(R-Tex.)



John Bryant
(D-Tex.)



Ronald D. Coleman
(D-Tex.)



Tom DeLay
(R-Tex.)



Jack Fields
(R-Tex.)



Pete Geren
(D-Tex.)



Ralph M. Hall
(D-Tex.)



Greg Laughlin
(D-Tex.)



Lamar S. Smith
(R-Tex.)

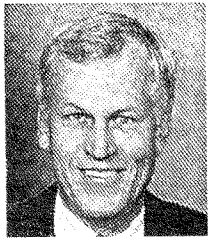

Charles W. Stenholm
(D-Tex.)



Charles Wilson
(D-Tex.)



James V. Hansen
(R-Utah)



Karen Shepherd
(D-Utah)



Thomas J. Bliley, Jr.
(R-Va.)



Robert W. Goodlatte
(R-Va.)



Lewis F. Payne
(D-Va.)



Jennifer Dunn
(R-Wash.)



Steven Gunderson
(R-Wisc.)



Gerald D. Kleczka
(D-Wisc.)



Thomas E. Petri
(R-Wisc.)



Toby Roth
(R-Wisc.)



F. James Sensenbrenner, Jr.
(R-Wisc.)



Craig Thomas
(R-Wyo.)

NOT PICTURED

- Rep. Lynn Schenk (D-Calif.)
- Rep. Fortney Pete Stark (D-Calif.)
- Rep. Thomas M. Foglietta (D-Pa.)

**CONGRESSIONAL GRACE CAUCUS
103RD CONGRESS** *As of April 13, 1994*

CAUCUS CO-CHAIRMEN

- Rep. Christopher Cox (R-Calif.)
- Rep. Frank Pallone, Jr. (D-N.J.)
- Sen. Hank Brown (R-Colo.)
- Sen. Herb Kohl (D-Wisc.)

NUMBER OF MEMBERS

	Senate	House	Total
Rep.	19	120	139
Dem.	13	45	58
Total	32	165	197

West Is Taking Back America!

Tenth Amendment Drives Vigorous Revolt

*Reprinted by permission: Tribune Media Services—
an article by Patrick J. Buchanan.*

WASHINGTON—Once again, the spirit of John C. Calhoun stalks the land.

"The powers not delegated to the United States by the Constitution, nor prohibited by it to the States, are reserved to the States, respectively, or to the people." So reads our long-forgotten 10th Amendment. Seizing on this amendment, Western states, fed up with federal despotism, are attempting a rollback of federal power and a rebirth of states' rights.

Illegal aliens, unfunded federal mandates, control of the land, guns—these are the issues driving a gathering national rebellion.

California has filed suit demanding the United States assume full cost of educating, medicating and imprisoning illegal aliens. The United States, says California, has ignored its constitutional duty to protect California from invasion, allowing her to be overrun by a million illegals every year.

Alaska, whose governor, Walter Hickel, won election as the candidate of a party advocating secession, has filed a \$29 billion suit charging the United States with locking up 100 million acres of Alaska's land in violation of the compact by which Alaska became a state.

Colorado has passed a 10th Amendment resolution ordering the United States to "cease and desist, effective immediately, mandates that are beyond the scope of the constitutionally delegated powers."

Tenth Amendment committees are sprouting up all over the West.

In Montana, Sheriff Jay Printz refused to enforce the Brady Bill mandating background checks on gun buyers. He has neither the time nor manpower, declared Sheriff Printz, adding, "We like our guns in Montana... It's not unusual for a person to have 15 guns or more."

In Billings, U.S. District Judge Charles C. Lovell ruled in favor of Printz, striking down that part of the Brady Bill. Under the 10th Amendment, ruled the judge, the federal government cannot force states to allocate resources to carry out federal responsibilities.

In Graham County, Ariz., Sheriff Richard Mack filed suit against Brady, saw his suit upheld, and became a folk hero, leading a parade of 20,000 in a protest against gun laws in Medford, Ore.

Sheriff Mack has a book coming out September, "From My Cold Dead Fingers," which he says, "gets into things like Waco and Bernhard Goetz and how the government's own documentation shows that the safest way to defend yourself is with a gun."

Like the Sagebrush Rebellion of 15 years ago, this revolt out of the West threatens to decimate the Democratic Party.

It is being driven by miners, ranchers and loggers who see a way of life being destroyed by judges and bureaucrats. It is backed by elected officials fed up with being ordered to meet the mandates of Congress and by taxpayers enraged at being robbed of property

rights by federal agencies without just compensation.

Beltway elites may scoff, but this rebellion is growing. One day it will manifest itself in acts more dramatic than a handful of sheriffs refusing to carry out Brady. In Colorado there is talk of the state withholding federal gas-tax revenues from Washington and spending the money directly on state highways.

In Catron County, N.M., rhetoric about "taking back America" has taken on real meaning. When the Forest Service curbed timber harvest to protect the habitat of the Mexican spotted owl, and started reviewing whether cattle grazing was endangering the range land, county officials drew up their own plan for managing the land. Forest rangers who tried to cut ranchers' livestock grazing permits were threatened with arrest.

"The Forest Service has been run off at gunpoint," say Susan Schock, a Silver City, N.M., environmentalist. "They've turned the forest over to the county."

"If we didn't have the plan, there would have been bloodshed," says rancher Dick Manning. "Things have gotten to that point."

Interior Secretary Bruce Babbitt, who is prosecuting Mr. Clinton's "War Against the West," chuckles at the "sovereign nation of Catron County." But Catron's defiance has inspired a nationwide "county movement," enlisting county and state governments in the battle against environmental regulators.

People for the West!, a new grass-roots organization, calls for increased, not diminished, development of the 500 million acres of federal land. It now has 30,000 members, has doubled its chapters in the last year, and claims credit for the Senate filibuster that forced Commissar Babbitt to retreat from his proposed hike in grazing fees.

Whose land is it, anyway? That is the question. And support is building behind a movement to have most of those 500 million acres of federal land turned over to the states, leaving decisions about the use and preservation of that land to the people who care most about it—the people who live on it!

The 10th Amendment rebellion is a cause that populists and conservatives ought not only to get behind, but out in front of.

Another Mind-Control Victim

[Editor's note: As you know, CONTACT has printed various articles concerning the mind control experiments by the power brokers of our Government. These programs, ranging from Monarch, to Project Phoenix, to outright chip implantation—each leave their scars on the people involved. Some of those scars are more visible than others. What you are about to read is one letter in a long series of letters we have received at CONTACT from this same person, who has been the product of microchip implantation, and yet you will see when reading this letter that the soul within him is reaching outside of the microchip programming. Another such person who has been writing to CONTACT for some time, Brian Wronge, is likewise a product of implantation. To quote from an article about Wronge from the Dec. 15-21, 1993 edition of THE CITY SUN (NYC), quoting an anatomist who had examined Wronge, "When I passed the microphone over his body, it picked up vibration and white noise—sound waves that would be emitted by computer chips." Yes, we live in a world much more technologically sinister than most realize.]

July 14/94

Greetings My Brother Rick

BRO I BID I AM ON THE RIGHT PATH HERE, FOR I WISH TO THANK YOU FOR ANOTHER GIFT THAT I HAVE RECEIVED TODAY THROUGH THE MAIL; TWO ISSUES OF "CONTACT" THE JUNE 28th. 1994 & JULY 5th. 1994 ISSUES.

I JUST SENT YOU A THANK YOU SCRIBE FOR YOUR GIFT OF RETURNING MY FACILITY CHECK BACK TO ME THROUGH OUR SISTER ZITA... & NOW THIS GIFT REACHED ME TODAY. PEACE MY BROTHER.

RICK I PRAY YOU HAVE BEEN RECEIVING THE ARTICLES I HAVE BEEN SENDING YA IN REGARDING TO THE DEGREES OF BRAIN WAVE FREQUENCY MONITORING CONTROLMENT & VICTIMIZINGS. YOU KNOW BRO IF SOMEHOW A GODLY POWER STRUCTURE WOULD STRAIGHT UP, OUT FRONT, FULL FORCE PROVE IN PHYSICAL EVIDENCE ABOUT THE REALITIES IN THE UNIVERSAL SCIENCES OF HUMAN DOMINATION CONTROLMENT THROUGH THE USES OF BRAIN WAVE FREQUENCY MONITORING EQUIPMENT & ITS EQUIPMENTS RELATED IMPLANTS; IT TRULY WOULD BE A BIG KICK IN THE EVIL ONES ASS. SMILE!

& GODLY SO, THEN THE NEXT STEP IS TO PROVE THAT IMPLANTS ARE NOT DIRECTLY NECESSARY NEEDED. RICK IF I WAS ON "CONTACTS" BOARD MEETINGS I WOULD BRING UP THE TRUE REALITIES ON HOW THERE IS MANY GODLY POWER STRUCTURES EXPOSING THESE TRUE UNIVERSAL HUMAN & ELECTRONICAL WAVE FREQUENCY SCIENCES. SUCH AS; CONTACT INC. & W.B.A.I. RADIO PROGRAM IN N.Y.C. & TEXE MARRS MINISTRIES & THE CITY SUN, IN BKLYN, N.Y. & CAMBRIDGE UNIVERSITY IN ENGLAND & STEVE CARLTON, THE BASEBALL PITCHER & BRAIN WRONGE THE BROTHER WITH IMPLANTS IN HIM, NEWS STORY IN THE CITY SUN & M.T.V. PRODUCERS & YES ME, THOMAS SALVATORE SAVONA, SMILE!

IMAGINE RICK IF EVERYONE CAME TOGETHER UNITEDLY, TO PUBLICLY EXPOSE TRUE UNIVERSAL HUMAN & ELECTRONICAL SCIENCES, WITH THEIR FULL BACKINGS OF THEIR POWER STRUCTURES; LAWYERS, DOCTORS, ELECTRICIANS, NEWS REPORTERS, REVERENDS, RADIO HOSTS, ETC. ETC. ETC. WHAT AN ARMY OF GODLY POWER STRUCTURED ONES MY BROTHER... & THE MAIN KEY RICK IS TO FORGET THEM, THE EVIL ONES, FORGET THEM!!! WE USE OUR OWN HUMAN & ELECTRONICAL SCIENCES, OUR OWN BRAIN WAVE FREQUENCY MONITORING EQUIPMENT, OUR OWN!!! & HOW IT CAN BE UNIVERSALLY GODLY USED FOR THE BETTERMENT OF OUR HUMAN RACE...

IT WOULD BE A KICK IN THEIR ASS, A VICTORY IN FULL FORCE EXPOSURE.

21

RICK, IF I WAS NOT A PRISONER OF WAR INCARCERATED PREVENTING ME FROM GATHERINGS EVERYONE UP TOGETHER IN PERSON... I WOULD DO IT!

& I USE MYSELF AS PHYSICAL EVIDENCE. I HAVE THESE IMPLANTS IN MY PHYSICAL COMPOSITION. WE COULD USE OUR EQUIPMENT, BREAK IN TO THEIR EQUIPMENTS IN COMING FREQUENCY, & TUNE INTO MY IMPLANTS OUTPUT FREQUENCIES THAT ORIGINALLY COME FROM MY BRAIN. THEN USE A PROTECTIVE FORCE FIELD FREQUENCY TO KEEP THEM OUT (SMILE). WE COULD EVEN TRACE THEIR LOCATIONS BY USING TRACER FREQUENCIES ON THEIR EQUIPMENTS OUT/PUT ONES. IF THEY CONTINUED MONITORED SYSTEMS, & FEEDBACK SYSTEMS.

MY BELOVED BROTHER I AM NO ELECTRONICAL OR HUMAN CERTIFIED DEGREED SCIENTIST, BUT I DO HAVE TRUE TO LIFE KNOWLEDGE FROM BEING VICTIMIZED. WHICH HAS TURNED INTO TRUE UNIVERSAL WISDOM.

BEFORE I CLOSE RICK, I WANT YA TO KNOW THAT TODAY ON "W.B.A.I. RADIO STATION IN N.Y.C. ON THE GARY NEVAL (SPELLING) SEGMENT, ~~THEY~~ WENT DEEPLY INTO THESE SCIENCES, & THEY HAVE APPROX: 100 C.I.A. AGENTS SOUL RAP/ING TO THEM.

YOU SEE MY BROTHER I TRULY DO NOT KNOW YOUR FULL POSITION IN "CONTACT" AS OF YET... BUT IF I WAS YOU RICK, I ACTIVATE ON JUST ABOUT EVERYTHING I SEND YA & TELL YA. SMILE!!

ONE MORE THING BRO, ITS HARD KEEPING MY MIND IN PEACE KNOWING IF YOU RECEIVE EVERYTHING I SEND YA, BECAUSE I KNOW THAT THE EVIL ONES ARE IN EVERY KIND OF STATE, GOVERNMENT, CITY, POLITICAL, RELIGIOUS, ENTERTAINMENT, SCIENCE, ORGANIZED CRIME, ETC. POWER STRUCTURE IN THIS COUNTRY & ABROAD. "THEIR EVIL HANDS & DOINGS ARE ALL OVER"

IT BE GOOD IF I HAD STRONG TIES OF A CORRESPONDENCE CONTACT IN "CONTACT" TO LET ME KNOW THEY DO RECEIVE EVERYTHING I SEND THEM... IN THAT WHICH I HAVE JUST SPOKEN IS FROM MY HEART & I BID YOU UNDERSTANDINGS IN WISDOM MY BROTHER RICK. PEACE!!

Have A Good Day Bro

AN IMMORTAL WARRIOR
SAYONARA

Grandma Torpedoes George Green

Editor's note: The following solid response is precipitated by and refers to a letter on page 48 from that master of mediocre prevarication, George Green—that's his signature at the bottom of the "America West Distributors" stationery. We see absolutely no need to add anything to "Grandma's" bullseye position.

F A X H A R D C O P Y

July 25, 1994

NOTICE TO CEASE AND DESIST
(May 12, 1994 letter affixed)

Contact, Inc. News
Attention; Rick Martin Editor

Dear Rick and Readers;

On this date, I did go to the mailbox, and there was a large envelope of "informations" addressed to Mrs. Russell Herman, there was "NO" return address.

Contained therein was a volluminious set of documents, slanderous remarks, breaches of legal counsel 'confidences' (as it is on the attorney's stationary), and other issues which I care not to comment on, nor do I wish to be a party to, nor do I care to know about, now, or at any time in the future.

These partys allege to be AMERICA WEST DISTRIBUTORS, P.O. Box 3300, Bozeman, Mt., as near as can be determined by their "materials".

Ladies and Gentlemen; "I" care not to get involved in any "HISSING MATCH" or any "Legal Contest" with any of you, nor will I stoop so low as to slander another individual without cause. If the "cause" be true, than I shall tell the truth...but; I WILL NEVER SLANDER A FELLOW MAN, nor cast a false light, in order to gain for my own personals.

This shall serve as NOTICE; CEASE and DESIST in sending any further materials such as was received this date. You know who you are as do I..., as you are liableous, slanderous, and you violate the Printers Ink Statutes, and you incite "unwanted" communications.

Mrs. Russell Herman ("Grandma")
P.O. Box 477
Okawville, IL. 62271

FURTHER SAYETH NAUGHT

/////

America West Distributors

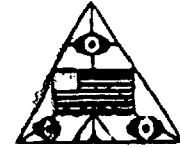

Post Office Box 3300
Bozeman, MT 59772
(406) 585-0700
FAX 585-0703

May 12, 1994

Dear Friends:

During the past two years the "Ekker"/Hatonn Cult has been slandering Desirée and I in their controlled paper.

They have also been attacking ANY OTHERS who know the truth with lies in their feeble attempt to distort and defame the truth. An example would be currently telling that they loaned, or gave \$18,000. to Bo Gritz. HAVE THEM PRODUCE THE CHECK!! I was at the meeting when it was suggested by EJ Ekker to loan them money. BO GRITZ DECLINED!!

EJ AND DORIS EKKER, two admitted bankrupts are in control of millions of dollars in the "phoenix Institute for Research and Education where they have manueverever the funds into many other corporations in an attempt to defraud the investors in which several are asking for their money back. The Ekkers sue them for anything in their attempt to keep from paying.

In the case of Leon Fort, his attorney received a couple of payments which he put into his trust account.. The question is if you have a demand note, and ask for your money back, WHY DOES ANYONE HAVE TO TAKE PAYMENTS? The letter enclosed from Fort explains it all. If you are unlucky enough to have money with these people, be advised that there is one attorney who represents several investors in now preparing receivership papers, and I hope that the D.A. who is investigating the case does protect the Ekkers by putting them behind bars so that they will be safe. They lie on their house, and since the beginning! Have you checked anything out! Call Jason Brent who bent over backwards to allow the Ekkers to produce proof that they had the money to buy it. Would you loan two bankrupts with no job \$180,000.? That is what they expect you to believe during the time they just got through going through bankruptcy and now they are threatening to do it again, in the guise of getting out the judgements ALREADY ENTERED AGAINST THEM by the courts. Please read the enclosed documents. Check it out. I have over two feet of court documents now!! They have now had 4 sets of attorneys quit them! Does that mean anything to you. The attorneys could be held liable personally if they represented fraud, and guess what? They all found out what was going on. May GOD show you the path ahead.. It is your personal responsibility to get truth, and we certainly don't need a person/entity to copy from other books !!!

"The Truth Will Set You Free"

Latest JOURNAL Goes To Press

Dedicated To Native Americans As Great Cleansing Proceeds

Editor's note: Readers, please keep in mind that it takes a good 8-10 weeks of publication and printing activities between the time that we announce the latest JOURNAL here, only GOING to press, and when that new JOURNAL is actually completed and available for purchase through Phoenix Source Distributors. Always look to the Back Page of CONTACT for JOURNAL availability information.

7/22/94 #1 HATONN

I am asked to write for the closed magazine, as we always do—one last “upfront” which usually has nothing to do with the journal in point—but nonetheless can bear any immediate information as it flows.

There IS that type of information from almost every corner of the globe but I think I shall let it go for the paper, or whatever, for the moment.

I have recently again received an abundance of copies (or originals) of documents that George Green is sending out to various people in an effort to discount both our work, our persons and allow himself to retain the thieved gold and cancel his debts to the Institute along with the journals in his possession—which he shows as being copyrighted to America West.

First, on the copyrights, to you who now inquire AGAIN. WE HAVE NO COPYRIGHTS ON ANYTHING EXCEPT SIPAPU ODYSSEY—FROM 1987. Our writings are current and dated material as you would find in any magazine or paper. We specifically demanded that NOTHING of this nature be copyrighted in any way whatsoever—we urge copying, distribution or however—we don't even care if you like it enough to CALL IT YOUR OWN.

DOCUMENTATION AND WRITERS

Our full and ONLY intent in offering works of anyone—is to present that which is available (and usually long-since buried or forgotten) as a reminder that truth has been there all along—you only needed to be nudged and SHARE. There is NO CORNER ON TRUTH and beware the person who claims same for self—always check WHY they might be doing so.

AS TO THE “WRITING” FROM ME IN OCTOBER OF '89

George is sending around a writing of mine from October 17, 1989 (which I ask be reprinted here to see what YOU see in it). He is sending it with the writing from DUGGAH which has already been discussed. [See p. 20]

In the writing of 1989 George is highlighting a portion of a paragraph which is going to make him look far more foolish than at present. He is sending this particular writing attached to the “Duggah” input in, I assume, some effort to validate “any” writing by “any” secre-

tary. I have no objection to the sharing—I would, however, point out that it is foolish to assume any intent other than that which is written!

Reference on my part was in response to “any ONE person saying they are the ONLY receiver for a being—should be watched very closely—AND SHOULD BE.” We have had several pass through and claim all sorts of things. Neither I, nor Dharma, has any corner on the TRUTH MARKET and surely there is no objection to every person on the globe communicating. However, be sure your communication is correct. I have had, AND HAVE, MANY receivers. I do NOT have MANY receivers to do a single job! You will, further, note that all these now claiming to commune with Hatonn—are solely focused on discounting Dharma and my work—using my own title. Is that not reason enough to suspect? If your focus is truth and validity—do you not evaluate input and judge content and discern reason for the firing squad?

The portion which George highlights is this bit of a sentence and, for the essence of me, I can't see how he thinks it helps his cause: “...Always beware of a speaker/receiver (channel) who presents themselves as the ONLY receiver for an energy—that is the evil brother shutting down your limits of accessing knowledge.” I mean that statement as much this minute as I did when I spoke it and you who read my material know I have never stopped warning you of same. I have said to READ **EVERYTHING**—“everything” means exactly that; the perceived good, the bad, the rotten, the perfect—HOW ELSE CAN YOU EVALUATE. Without “bad” no one can recognize or experience “good”! I think the next sentence is of far more value—but I guess does not seem to serve the Green Brigade: “We of these realms would never burden a given human being with such a load nor would the remainder of the peoples be limited to access to knowledge in other locales distant from that physical outlet. Be most cautious—actually, use your God-given sense of reasoning.”

I do not even discount one “Duggah”—I simply state unequivocally that that writing in point IS NOT FROM “ME”! THAT does not make the receiver lesser—but I would betcha anything you want to bargain—that that receiver is certainly a FRIEND of George's or at the least “on his side” of this debate OVER THE GOLD! IF, in fact, George doubted my truth or validity—WHY DID HE CLAIM TO THE WORLD THAT I WENT TO NEVADA WITH HIM AND FURTHER, THAT HE “STILL IS TRYING TO GET THE WORD OUT?”

LETTERS TO AND FROM ATTORNEYS AND THE INSTITUTE

It is difficult, further, to understand what value or proof of wrongdoing can be gathered in any manner whatsoever by the President of

the Phoenix Institute and George's attorney, Horton, over the setting of court dates. Is not the President of the Institute (in the same way as George was responsible for the fiduciary care of that same Institute while he served as both officer and director), supposed to attend these matters—especially without legal counsel? Will someone explain to all of us why “George” would be sending these legal documents to the world-wide mailing audience?

T. DAVID HORTON

Since George is also sending a “Bulletin” about T. David Horton to “EVERYBODY”, I am also asked to comment on Mr. Horton. I think George really isn't going to like this response—and probably neither will David Horton. However, you will recall that the Nevada “reporter” who spoke with Mr. Horton told Mr. Christie that if the things are proven against Green that he “would have no problem working with Ekkers.” And further, according to the reporter: “...I have found no reason to not believe the Ekkers.” Now, if Mr. Horton did not say that—so be it, we can only work with that WHICH IS.

David Horton is touted as a “Constitutional” Attorney. I think that is BECAUSE he is studied in Constitutional Law and would actually like to see a legal system and a nation run UNDER THOSE LAWS. I have no quarrel with David Horton.

What would you do? George Green went to get an attorney to protect his interests and Horton took the case. He is obligated to do the very best he can for his client. Further, his own time and efforts must be paid for—for that seems to be the biggest name of this game. Truth second, pay first!

What would YOU do if a very genuine person came to you and claimed he has broken with a cult, a bunch of weirdos who are being investigated by the Feds? FACTS speak otherwise—but THOSE don't surface until MUCH LATER! WHY David continues the association is that which is puzzling to me—because he, IF he is what he claims—a Constitutional advocate—he will be working with our team. It simply is the way it will be—I am not going to “go away” and I certainly hope sincerely that NEITHER DOES HE—HONEST ATTORNEYS ARE THE ONE THING NEEDED MORE THAN ANYTHING ELSE TO FACE THE JUDICIAL CORRUPTION. IF he is otherwise and working against you—that will also surface. It is, however, also impossible for me to believe that Horton actually believes Green about such as the Overton Gold—Horton did the deposition of Overton in Texas and there was no doubt of Overton's intentions.

Another point which confronts us is what a shame it is that right under Horton's nose is THE ONE who can do the most to provide legal return to the Constitution—in the legal case already set and scheduled before the court. He COULD HAVE BEEN meeting and conferring DAILY with Jackson—right in his dooryard. So, readers, I know that George is sending the bulletin to impress you with his credibility—but is actually discrediting Horton. I cannot do a thing about that nor would I effort at such a thing—Horton is too valuable to you as citizens. George is simply discrediting the integrity of the COMMITTEE TO RESTORE THE CONSTITUTION which claims to have been founded in 1965. Now it is quite remarkable, however, that John Coleman's research notes that this is only a branch of the

Committee of 300-controlled groups. Is this true? Who knows? I just want you to evaluate the INFORMATION and TESTIMONY offered by this person in point—to the State Senate Committee on the Judiciary, Topeka, Kansas on August 23, 1979. This is what gained him the reference of "Constitutional Attorney".

I can assure you that the REASON George is sending the document is for gaining his own credibility through Horton and not the information—because the first page about Horton is THE ONLY PORTION SENT!

PAGES OF A WRITING

It will also be noted that only the portion of MY writing which served Green—is utilized—the best part is in the rest of the writing!!

WHY THESE PARTICULAR LEGAL DISCOURSES SENT?

Because George has pushed Horton to do something which was a breach of ethics—or at the least borderline. George has a HABIT of taking information before it is even settled, signed or in use, along with very private business ledger copies and spreading them all over the map. This has caused a total impasse with his own claimed friend, Leon Fort—because George Green actually gained copies of "client ledger runs" and sent them to his mailing list—negating the AGREEMENT between the Institute and Fort. This was a court-ordered privacy agreement and payments had been made—to Mr. Fort's attorney, Abbott. Abbott cashed those checks (in a very large amount) and now claims otherwise. However, the cause of action stemmed from the documents and prattlings of George Green—in the first place. I don't know why his own attorneys allow him to walk around in good health—much the less continue to make themselves look like blithering fools while claiming to SAVE THE CONSTITUTION FOR DECENT LAW AND ORDER. That, however, is for them to choose direction—and YOU to discern intent.

We assume this most recent mailing has been widely scattered and was pretty "desperate" in reaching on the part of Green. I hope this will suffice rather than individual responses. There are far too many references for us to answer individually and get anything else done. Further, and I appreciate the sequence—the letters are to ME and I honor that because Dharma has "had enough" while serving ONLY in our consideration.

If you prefer Duggah's input—it will make your way "easier", probably—for it won't give you cause to seek Truth or follow many guidelines—just BE and DO and REMAIN PRETTY BLIND!

I AM NOT ON TRIAL

I am not on trial in this case with Green which Horton heads—GEORGE GREEN IS ON TRIAL! He took gold which was not his; he has not honored his debts; he has formed conspiracies to ruin a valid corporation (in Horton's Nevada), and holds a whole bunch of journals which were originally set aside as collateral for the loan to George from the Institute. This is NOT the case with US&P of which Horton has no involvement TO OUR KNOWLEDGE! There is personal input, but that is not important for it is not official. George made secret agreements with US&P and then continued to act in contempt of court—while dumping all blame and even using "THEIR" attorney to

effort, again, at destruction of our people and credibility. YOU BE THE JUDGE AND ALL OF YOU CAN BE THE JURY—BUT BE CAREFUL, FOR GEORGE IS THE ONE SENDING ALL THE DOCUMENTS—AND THEY ARE CAREFULLY EDITED AND THE COURT DOCUMENTS ONLY REPRESENT THE MISREPRESENTATION HE HIMSELF PRESENTED TO THE COURT! Moreover, with Mr. Horton standing there as Green's lawyer—George LIED on the witness stand, under oath, in Nevada with a roomful of witnesses. CAN THEY WIN? THAT IS NOT THE QUESTION IN YOUR JUDICIAL SYSTEM ANY MORE, IS IT? GEORGE CLAIMS TO BE "AN INSIDER" WITH THE FEDS—AN AGENT—NOW, YOU TELL ME! Funny thing, though, HE DOES NOT ACT LIKE A MAN WHO HAS SOMETHING ALREADY UNDER LOCK AND KEY—DOES HE? I REMIND YOU—"TRUTH WILL 'OUT'"—IT ALWAYS DOES, AND BADLY "USING" ANYONE IN YOUR LIES, EVEN AN ATTORNEY (PERHAPS "ESPECIALLY" AN ATTORNEY) WILL COME BACK TO EAT YOU ALIVE.

There IS GOING TO BE A CHANGE IN YOUR NATION—AND A LOT OF THE GARBAGE IS GOING TO BE SORTED! Selfish actions and causes are not going to sell well to the "old buddies" because now everything is at stake and the primary clue about people—is there is no loyalty among thieves when the chips are all cast down and in the open!

ERNEST KRIKAVA

We have been asked to bring something to your attention of which many of you will already have awareness.

In Kansas very near the Nebraska border a typically horrendous thing has happened which has now been featured twice on the TV show called *Current Affair*. This is just ONE of thousands but is so painful as to be unavoidable in focus.

In 1991, a very bad farming year, the Krikavas (farmers—grain and pigs) had to take loans to survive. Then the bank foreclosed. Things were desperate and some pigs were sold in order to keep the remaining stock from starving. The bank claimed the pigs—AND THIS WEEK MR. ERNEST KRIKAVA WENT TO FT. LEAVENWORTH FEDERAL PRISON FOR A FIVE MONTH SENTENCE—FOR SELLING THOSE FEW HEAD OF PIGS TO GET PIG FOOD.

Mrs. Carol Krikava died during this time—of stress and, frankly, a broken heart. This farm is a three-generation holding. Son, Kevin, attends with his father, Ernest. Ernest is elderly—in his late seventies.

Current Affair is offering this plea to all listeners and readers, friends and citizens asking you to contact [Atty. Gen.] Reno and plead for a pardon for this Godly man—being destroyed by the system.

I wish it were only ONE—it is not even the only one in the immediate area of Seneca, Kansas—but it IS one which has made its full circle and placed an innocent, Godly man IN A FEDERAL PRISON—FOR A HANDFUL OF PIG FOOD!

We KNOW that our readers pitch in with support of this type and encouragement to the ones who are helpless. Therefore I again ask your assistance for these beautiful people under incredible pressure. When we can do so, we hope to establish a fund for genuine assistance to these types of people. There is funding available—it is just the "getting" that is the problem—EVERY TIME. But one of

these "times" the Feds are going to have to release it. In the meantime—if addresses can be gathered, please give support to the Krikavas remaining—Ernest (at prison) and Kevin (home trying to stay alive and afloat). [Editor's note: To write to Ernest Krikava, send to Kevin Krikava: Route 3, Box 96, Pawnee City, NE 68420. You may also write to the Current Affair television program at: Free The Farmer, c/o Current Affair, Box 5363, FDR Station, New York, NY 10150-5362, and your letters will be delivered to Washington, DC.]

If addresses cannot be gotten, there are some family friends, Bill Keegan and Herb Klepper who were featured and might be a conduit as well as Krikava's attorneys Lisa Lozano and Bill Chapin.

If that doesn't work—then embarrass the bank (or do both) by writing, etc., the COMMUNITY NATIONAL BANK in Seneca, Kansas.

In referring to Ernest (in prison) it is the Ft. Leavenworth, Kansas Federal Prison. Ernest's registration number for reference is: 13958047.

Current Affair is asking that you write: Attorney General Janet Reno, U.S. Dept. of Justice, 10th & Constitution Ave., NW, Room 4400, Washington, D.C. 20530. I don't know if this will work—but over 120,000 letters from you readers to the Governor of Nevada is about to get Jackson free—and it got Gunther out of the Missouri Prison—AND relocated into a private residence for Gunther in Austria. THE PEN IS MIGHTY—BUT YOU HAVE TO USE IT.

Perhaps those two nice farmers would like to raise my grain and pigs in California—the Feds are obviously taking all the land everywhere—but tiny subsistence farms are still around if you can keep from owing the Feds anything. The land grab around California is worse than almost anywhere—and REASONS far more interesting (like mice and rat protection) and thus and so. In the Mid-West grain belt the land is now grabbed away as "wetlands". REMEMBER THE PLAN—THEY INTEND TO HAVE EVERYTHING, ANYWAY THEY CAN GET IT FROM YOU!

Indeed, Mr. Horton could really make a contribution—if he ever opens his eyes to the truth of it!

George sends Mr. Horton's information so you can all write to him for facts—I SUGGEST YOU ALL DO THAT. The street address is marked out with information to mail to P.O. Box 2107, Carson City, Nevada 89702. According to Mr. Enz's response, the street address is 105 Adams Street, Carson City, Nevada. This, I suppose, for you who would visit. Phone: (702) 883-1966, Fax: (702) 883-1984.

INFORMATION IN THIS JOURNAL

The variety of information offered in this journal is seemingly on opposite ends of the poles. No—it is so connected that I cannot urge you strongly enough—TO MAKE THE CONNECTIONS. It runs from Clinton-istas, through Usurpers of other ilk to and into the Hopi (AmerIndian) projections and prophetic offerings—along with HOW IT WAS AND IS.

I remind you that PROPHECIES are only the telling of that which has been experienced—and unfolds as it WAS—the "future" is for the CREATING! The information and speakings along with perceived "actions" along the way—are TOOLS for your WISE CREATING. Wisdom is Sacred—and so, this journal will be called for identification: SACRED WISDOM.

Gyeorgos Ceres Hatonn
IGFF-PSC
July 22, 1994

Title of journal:

SACRED WISDOM

PROPHECIES ARE THAT WHICH
HAS BEEN AND REPEATED;
THE "FUTURE" IS FOR "CREATING"
THAT WHICH WILL BE.

As you come to recognize the script and the players within the PLAY and PLAN you will see that naught is but a rerun of that which was wrong and never corrected—repeating of that

which should have been corrected. The "future", therefore, is an open slate for the creation of the script and play. It is the opportunity to utilize wisdom, knowledge and "knowing" that prophecies do not have to be repeated in error of action and perception. May GOD guide your thoughts—for thoughts ARE CREATION!

DEDICATION

To my aboriginal brothers and sisters, I have returned. I am the 'light' (white) brother and I bear my half of the tablets as we parted ways from the Sipapu journey. I am sent again back that we can bring our people home. It is the time of the great cleansing and brother will join with brother in these days that the tribes

of the Great Spirit Creator can gather in our great migration—in truth. Be not looking back to that which might have been for ALL simply IS and the wheel has turned back upon its endless self and the way shall be given.

I would ask all of you who read this to prepare and what we shall share of the ancient journeys, and the wisdom to use in the NOW shall be focused through your winged brother we shall call Little Crow of the Lakota—for he is my teacher and accepted the feathered cloak of burden.

I can fly beyond the dimensions in my great circled wings—beyond the hummingbird, the mocking bird and the hawk—and ye shall also come forth through that sky-window for you are MY TRIBES and I am sent that your wisdom shall be kept forever.

Physics Of The Mind

Magnificent Dance Of Truly Conscious Life

7/24/94 #1 HATONN

EYE PROTECTION

Let us not damage ourselves because of perceived ridicule and stupidity of this limited civilization. Ask any blind person if it would not make living far more pleasant and easy to be sighted.

There is a LOT afoot in your non- or anti-civilization these days, not the least of which is a utilization of energy fields of quite a variety to accomplish anti-civilization goals [see *Front Page story*]. **KEEPTHOSE DARK-LENSED PROTECTIVE EYE COVERINGS HANDY**, especially through the end of this month and we can measure feedback and chain reaction of the artificial energy motion.

I do not expect to have you understand what I am talking about if you are not a scientist and, if you cannot believe except through the brain of a scientist—you are going to be locked into the limitations of your anti-civilization consciousness. Sounds big and a bit "far-out"? Yes, but it is not further than between your eyes, and perception is totally a thing between your ears called MIND.

LIVING "THROUGH" WITHOUT DAMAGE?

Can you make it through these times of bombardment by intentional technology? Yes—but WILL you? Are YOU informed enough and KNOWING enough? I don't see many who are prepared and actually capable of pulling it off in Truth—instead of your limited perceptions. Most of you remain totally locked by lies to your conscious realizations about you—not capable of REAL consciousness.

CIVILIZATION OF THE UNIVERSE

Oh yes, it DOES get a bit more complex in a false civilization to consider that you are actually in preparation to either remain in "limitation" or move on within the Civilization of the Universe. I DID NOT say "Universal Civilization"!

WHY DO I PICK THIS SUBJECT NOW?

Because there are things happening in your limited experience and ones joining in the limited world who can more easily INFORM YOU of physical experience and who are important "players". But YOU who would travel beyond this plane of thought and comprehension and into freedom in Truth—have to get on with your transitional lessons. Worse (or best) is that you must grow up through the MISperceptions.

SCIENCE

Ah, you think Newton and Einstein are wondrous and "absolute" thinkers and theorists? No, they are BOTH incorrect in their assumptions. **THEY KNOW IT NOW—IT ELUDED THEM AS TO ABSOLUTES WHILE PARTICIPATING IN YOUR PLANE OF EXPRESSION.**

Yes, I can give you a big bunch of data and only a handful of experiencers would understand. Then there would come the ones who would bury the information—as on "LIGHT" which "IS" so that you never gain insight into REALITY of mind CREATION and reproduction.

HOW IT IS PERCEIVED

You must look at that which appears to be—about you. You have to know the players and the play—but beyond that you need not do anything except KNOW TRUTH. Ah, but therein lies the real bug-a-boo! Some will base their explanations on religious journeys, perceived things which ARE NOT and then move you further into your limitations by suggesting you learn ascension and mental travel—WHILE SUGGESTING YOU HANG ONTO THE PHYSICAL. Can you do these things? Yes, but not the way expressed!

YOU are the creative force—NOT SOME "GOD" OF FAR-OFF OTHER-LAND! Is there "Creative Force" of allness—oneness-everything-there-isness? YES, but you are attached like super-glue to two pieces of thin paper. THAT expression WILL DO NOTHING—until YOU understand.

CONSCIOUSNESS

Consciousness is not only an eternal part of existence, but it is the controller of existence. It is the "seminal" value from which all other values flow—without exception. To begin to comprehend this point you must look at axiomatic EXISTENCE. Obviously, in some "form", "existence" IS. Further, existence is infinite and eternal; and consciousness, therefore, is eternal and infinite—and therefore IS the controller of all that IS.

KNOWLEDGE

What exactly is knowledge? Well, ALL knowledge is contextual—it MUST be so. In this understanding of basic truth then, ALL

valid ideas or theories are paradigms (MODELS) of contextual FACTS.

Next comes a biggie: **CONSCIOUS KNOWLEDGE is limitless and infinite BECAUSE KNOWLEDGE, GEOMETRICALLY, BEGETS NEW KNOWLEDGE.**

ESSENCE OF NATURE OF HUMAN

The essence and nature of human consciousness is **GOODNESS**. Note—I said “human”. What you HAVE running around are a bunch of “human-like” physically coagulated beings—I guess a good all-around term could be “humanoid”—but definitely not of the Civilization of the Universe. Rather, very locked and dedicated to physical expression and robotically trained humanoid facsimiles—**IN APPEARANCE ONLY**. The civilization of Earth-bound “man” is certainly not focused on “goodness”—but rather, abounds in crashing and thrashing at mere existence in your present FORM or actually seeking to CONTROL ALL THERE IS IN THAT EXPRESSION. Further, the essence of the nature of human consciousness is noble, rational, honest, just, compassionate, value producing, benevolent, kind, loving, happy...! Look around you, even in your “churches” filled with false-teachings, do you find these qualities in individual human-coagulated machines calling themselves humans?

Where is your JUSTNESS? NEVER in the “churches”—for if you are a Baptist and a Catholic enters the scene—he is not acceptable—so you have NO justness and GOD IS JUST.

THE GREATEST SOCIAL VALUE AMONG CONSCIOUS BEINGS IS OBJECTIVE LAW AND JUSTICE. How much of either do you find about you these days? Ever? Have things REALLY changed at all on the physical plane? From when? To when? There have ALWAYS been the “few” who KNEW TRUTH! Remember? Nobody listened? So be it, surely enough, man remained anti-human and anti-civilization.

I don't even like to refer to the so-called “anti-Christ” by such foolish terminology (but I am stuck with your language)—because it is not a valid term for anything—the term in correct presentation would be “anti-civilization” or “anti-humanity”. Certainly the thrust of the “anti-” beings is to keep YOU from realization of the Civilization of the Universe—wherein humanity and ordered civilization IS!

DISEASES

You all worry constantly about this disease or that disease and allow your bodies to be riddled, bombarded and destroyed by same. **THE ONLY DISEASES OF HUMAN CONSCIOUSNESS ARE DISHONESTY, MYSTICISM, AND IRRATIONALITY! These diseases cause all wars and crimes, including all property destructions, harms, sufferings, cruelties, injuries, and deaths PURPOSELY inflicted on human beings. THOSE DISEASES DESTROY THE NATURAL GOOD OF HUMAN CONSCIOUSNESS.** Furthermore, all such evils are inflicted by force or fraud to support the lives of open criminals (whom we will call subhumans) such as you think of in “Mafia”, robbers or muggers...or the much MORE EVIL, hidden criminals (these humanoids I spoke of) such as dishonest politicians, parasitical elites, tyrannical rulers,

bogus authorities, killer-type (Ruby Ridge, Idaho; Waco, Texas...) bureaucrats, and their force-backed ego “JUSTICE” systems of injustice. You can realize and name the little groups (or big groups) which serve the thugs and humanoids (and even some who serve the subhumans).

Let us refer to these beings who are human-like (humanoids, false-humans) beings who have hidden rationality and camouflaged irrationality and use this camouflaged irrationality to deceptively harm, ruin, and kill human beings as pseudo-humans.

Pseudo-humans are, therefore, human-copies or humanoids in whom the diseases of dishonesty and irrationality have destroyed the human nature of their CONSCIOUSNESS. So it is thus that such pseudo-humans are NO LONGER HUMAN BEINGS. They are simply humanoids who have destroyed their natural conscious structures and human essences [which are] NEEDED TO ENTER THE CIVILIZATION OF THE UNIVERSE.

PARASITES

These false- or pseudo-humans are PARASITES—ALWAYS! And, to parasitically exist, pseudo-humans purposely propagate a bizarre, irrational civilization on any “mankind-inhabited third dimensionally perceived planet” and certainly on Planet Earth “Shan”.

MACROSCOPIC Vs. MICROSCOPIC

This unnatural, transitory anti-civilization in MACROSCOPIC existence is likened analogously to the unnatural, transitory antiparticle in microscopic existence. Think about it. As the bizarre antiparticle vanishes forever on contact with natural matter, the bizarre anti-civilization will vanish forever on contact with the natural Civilization of the Universe.

We can talk about these things but there will be the ones among you who will understand the perception scientifically enough to explain the contextual intent.

ADVANCED CIVILIZATIONS

Ah, I do not speak of simple technology advances. I speak of ADVANCED CIVILIZATIONS. THE SUPREME VALUE OF HUMAN CONSCIOUSNESS WILL ALWAYS BE PRE-

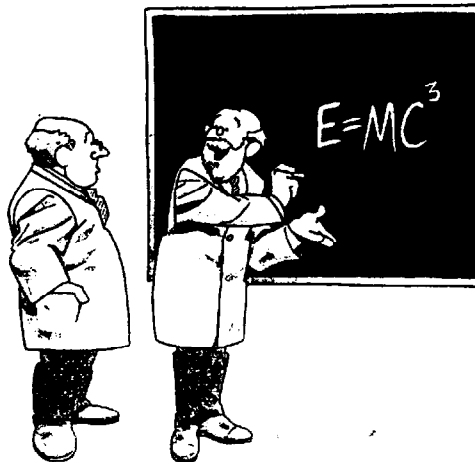

“What the heck...I figure it's close enough for government work.”

SERVED BY ADVANCED CIVILIZATIONS USING FIVE-DIMENSIONAL, MASS/ENERGY TRANSCEIVER TECHNOLOGIES. (Exactly as WE ARE now doing.) These technologies integrate rational consciousness with the Civilization of the Universe.

By the very fact of their continued existence, all civilizations technologically advanced significantly past their Nuclear-Decision Thresholds (which you NOW are) are free from the diseases of dishonesty, mysticism, and irrationality. Therefore you cannot enter into that civilization WITH these characteristics—and thus it is necessary to LEARN and KNOW BEYOND those traits which are destructive to the ongoing consciousness of “human” (higher Universal MAN). A major dividing line in progressive soul expression comes at the Nuclear-Decision Threshold. A species in a given civilization will make it or break it, figuratively speaking, at that point. You are now very primitive in your evolution—but technologically (in a physical way) to play with that which is NON-PHYSICAL AND NON-CONTROLLABLE FROM PHYSICAL STANDPOINT, to destroy the very manifestation of mankind as expressed in your experience. Pseudo-humans will NOT be allowed into the Civilization of the Universe! They will be VANISHED! I said “VANISHED” not “vanquished”. I have used the term “uncreated” and that has brought the house down on my scribe and myself. Well, call it what you will—these false-humans will cease to exist!

YOU cannot look into the next-moment with assurance or certainty—for it is only a perception as changeable as the MIND. Much the less can YOU in your limited bindings even begin to imagine the limitless expression of the technological states and economies of the advanced SOCIETIES throughout the Civilization of the Universe.

Does this mean you should not seek out the wondrous advancement and expressions, luxuries and wealth of that which you are experiencing? No—it means that you must grow into realizing you CAN HAVE THOSE THINGS AND REMAIN “HUMAN” WITH ALL THE ATTRIBUTES OF GOODLY CONSCIOUSNESS. The other aspects WILL BE VANISHED!

LAWS OF CREATION

No society or civilization, regardless of how advanced, can contradict the contextual laws of either physics or nature. Moreover, you can KNOW that conscious beings throughout the Civilization of the Universe will NEVER purposely violate their nature, well being, and happiness. The BASIC NATURE of rational conscious beings has never and will never change. No rational being would ever let technology overtake his or her nature, self-control, self-responsibility, growth, and happiness. Because that loss of control over one's SELF—one's greatest value—would be IRRATIONAL—the prime trait of a pseudo-human in anti-civilization. And, all conscious beings in the Civilization of the Universe are FREE OF IRRATIONALITY or any other impediments to individual consciousness, growth, and happiness.

It evolves, then, that all conscious beings in the Civilization of the Universe have the same nature: They (we) all live for rational happiness and its emotions of GENUINE self-esteem and love. Indeed, the moral purpose of all conscious beings is to meet the rational requirements of achieving true happiness.

NATURE OF EXISTENCE

The nature of existence includes:

1. Objective law and justice which is totally characteristic of the Civilization of the Universe,
2. The limitless value of each conscious being when functioning in a rational civilization,
3. The dynamics of continually expanding value production and prosperity, which demand preserving the eternally supreme VALUE of every conscious being.

ANTI-CIVILIZATION CHARACTERISTICS

Possibly the most bizarre characteristics of the "anti-civilization" are its overpopulation and aging problems. Yes, that is exactly what I said. And you will note that the anti-civilization ELITE are trying to depopulate and totally control all aspects of the humanoid experience. They would wish to also control the "human" experience—but once a true "human" comprehends and KNOWS Truth—there is NO "control" available. That requires, then, the never allowing of Truth to be KNOWN to the masses of false- or developing-humans.

In any rational civilization, overpopulation and aging ARE IMPOSSIBLE. Exactly the opposite occurs. When free of destructive humanoids, each conscious being is free to productively, culturally, and artistically innovate and flourish without limits, becoming a priceless value to others and society. For, each conscious being in a RATIONAL civilization innovates and produces through division-of-labor dynamics far more values and resources than he or she consumes. This is always an increasing in value, with entropy never increasing, and conscious beings remain forever young for there is no "age" consideration.

In the never-ending Civilization of the Universe, a great demand for volitional conscious beings ALWAYS EXISTS. When free in an open and rational society based on objective law, each conscious being enormously benefits and enriches all other conscious beings. Through and throughout eternity, therefore, each conscious being will contribute more value to society than its entire population at any given point of time.

Knowledge and technology increase endlessly. All advancing civilizations require developing ever greater and cheaper energy sources and production efficiencies.

Prosperity and happiness of conscious beings do NOT depend on their actual level of knowledge or technology, but on their rational thinking and acting processes required for continuously advancing knowledge, technology, and beauty from any level.

Throughout the universe, every level of advancing knowledge and technology exists. Thus exists a technological level of conscious beings whose most efficient production of values depends on the unsupervised development and utilization of FREE-WILL conscious beings having the technological capabilities and economic-growth needs for which each additional, volitionally developed, conscious being would be of immense, irreplaceable value. Thus, honest conscious beings anywhere in existence are NEVER ALLOWED TO PERISH. So my suggestion is to always travel in the correct direction and remain both conscious and honest.

REDEMPTION?

By golly, you all want to have something or someone SAVE YOU! Until you understand WHAT YOU ARE—there is no meaning to a term such as "save".

Even in Earth's anti-civilization, EVERY volitionally developed, honest conscious being is redeemed and transceived into the Civilization of the Universe. **IN OTHER WORDS, ESSENTIALLY EVERY HONEST CONSCIOUS BEING WHO HAS EVER LIVED ON EARTH CONTINUES TO LIVE, FLOURISHING ETERNALLY, IN THE CIVILIZATION OF THE UNIVERSE. BUT, ALL HARMFUL HUMANOIDS OF PAST HISTORY SELF-PROGRAMMED THEMSELVES TO VANISH FROM EXISTENCE FOREVER!!!!**

Are you beginning to see the necessity of KNOWING TRUTH and stopping the absorption of all the garbage and lies?

This can be proven by physical measurements of field changes of human beings, humanoids, and animals as they "die". Such experiments, moreover, would support the fact that human consciousness transceives into the Civilization of the Universe, WHILE HUMANOIDS VANISH FOREVER.

SCIENTIFICALLY SPEAKING...

You must come to understand the true MEANING of "existence". What is existence? Well, readers, when you understand the true and REAL meaning of "existence" you have the "everything".

You can get incredibly rich in every connotation or meaning of the word "rich"—by accepting, and utilization through understanding of this one concept. You can control existence by controlling the force fields of existence. EXISTENCE exists as an open-ended electroplasma with no prior "causes". I suppose I can explain this some way in which I do not intrude on the holding of US&P and "LIGHT".

Let us consider, existence exists as an open-ended electroplasma, always evolving through its interacting matter (M) and energy (E) fields or modes. Those two fields of existence also eternally interchange in a relationship expressed by Dr. Einstein as $M=E/C^2$ (from $E=MC^2$), with C being the universal constant representing the speed of light.

Existence MUST EXIST—it cannot NOT exist. Moreover, no vacuum void of existence is possible. "Vacuums" of the matter field can exist as in outer space, in vacuum-pumped containers, and in areas between electrons. But, all those volumes are FILLED with the generally unmovable, frictionless ENERGY ether or field—a uniform, continuous field of energy.

An all-pervasive energy mode is somewhat analogous to a combination of: 1. Dirac's ocean in which exists an endless energy field of "electrons" or energy fluctuations at all points throughout space and, 2. Faraday's nonmatter, stationary lines or fields of force. All known energy modes can pressure wave through the energy/matter ratios of outer space. Most

modes are absorbed or changed either at energy/matter ratios of Earth's atmosphere or at energy/matter ratios of physical liquids or solids, while neutrino wave pressures can pass through the electron/nuclear fields of thick solid masses, even through planet Earth without mode change. This resurrection of an ether, not as a matter field, but as a fixed energy field, reconciles Newton's Classical Laws and Einstein's Relativity with Quantum Mechanics. Such a reconciliation arises from a universal "Zon" constant, K, which, in turn, arises from the conscious control of the energy field or ether manifested at every point of existence. The resulting causal control of existence by eternal conscious beings is: a. universal, b. fixed and unmovable, and c. independent of any frame of reference or method of observation.

I would point out before going further that this is not for most of you—and even with the scientific mind GEARED to this very purpose it may have some quirks of speech or semantics which are at first meaningless. For instance what is "Zon"? It can mean "everything" or "nothing" but each component part of an equation needs a label. Now, as with $E=MC^2$ or whatever—WHAT IS "C"? It represents the universal constant which represents the speed of light—to you. It SHOULD REPRESENT "consciousness"—THE SPEED OF CONSCIOUSNESS—NOT LIGHT, IF YOU ARE TO BE ACCURATE! Are you with me so far, Dr. Young? [Editor's note: Yes, indeed! This is a magnificent writing, loaded with important connections between mind and physical realities.]

Let us momentarily consider matter and its mechanical "energies" of mass, expressed as chemical, potential, and kinetic energies, which generally move in particulate or mechanical-like motions, largely in accord with classical Newtonian laws, ranging from atomic and molecular motions, to sound waves, to celestial motions. And by the way, Mr. Newton is a whole heck of a lot better informed today than when he projected "gravity" as he can now stand on MY shoulders instead of just those humanoids who came before him.

Throughout endlessly evolving existence, energy as a massless field uniformly occupies every point not occupied by mass. This energy field behaves essentially as a stationary wave vibration. While taken as a whole, both energy and matter modes combine to form physical existence, always behaving in dynamic combinations of one mode or field interacting with

BY BUNNY HOEST AND JOHN REINER

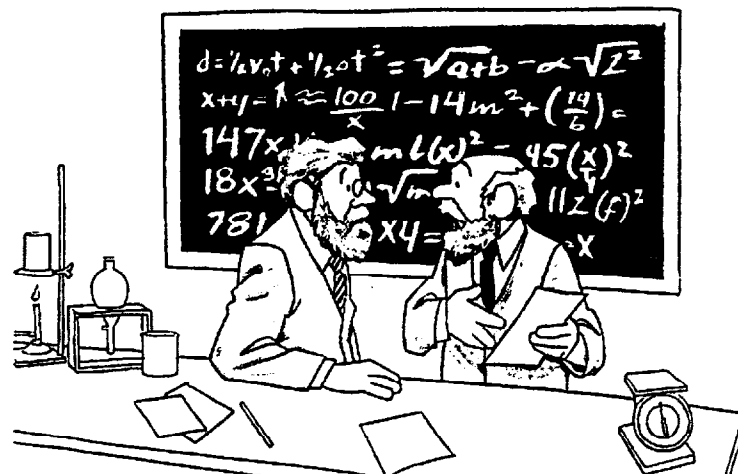

"Hair-restorer? You're supposed to be working on 'Star Wars!'"

the other. Moreover, certain motions of the matter field convert at the quantum level to the energy field—convert into quanta or irreducible packets of energy. Those irreducible quanta or PHOTONS of energy send relief-seeking signals into the continuous energy field radiating throughout existence.

CONSCIOUS CONTROL OF FORCE FIELDS

During its "creation", each new energy quantum slips smoothly and continuously from its matter field into the energy field. Like water flowing from a dripping faucet, each quantum is pinched off into a minimum-energy wave packet. Simultaneously, from the continuous energy flow, a new quantum starts its formation. Thus, continuous, smooth-flowing energy forms discrete PHOTONS. In turn, those PHOTONS or pinched-off wave packets of *minimum energy matter* create field disturbances or nonequilibrium pressures radiating in all directions throughout existence—signals throughout the endless energy field. Such signals travel near or at the speed of light—the velocity of cosmic energy. This is not a pushing pressure, but a nonsymmetry or disturbance pressure of *energy* seeking symmetry or equilibrium. What is detected represents, but does not resemble, what is transmitted. By contrast, a pressure of *mass* intruding into the matrix of force-field energies causes that elastic matrix to bend, or space to curve which, in turn, causes least-action gravity. The relationship between mass, curved space, and gravity require a fixed energy field throughout existence. We won't go further into this and its variety of expressions at this writing but I hope you begin to get the point.

Eventually, each point line of energy disturbance or pressure is relieved by a matter receptor that absorbs that line of energy as a smooth, continuous energy flow converted back into pinched-off packets of *minimum matter energy*—chemical, potential, or kinetic. In other words, the receptor relieves that energy pressure by locally absorbing energy quanta equivalent to the quanta from the originating source. Each absorbed quantum is then converted back into the equivalent of its original mode. Such exchanges of modes can be detected as a wave/particle in the energy field, or a particle/wave in the matter field, or a combination, depending on how and where that mode-exchange dynamic is measured.

In measurements, the distinction between metaphysical and epistemological certainties and uncertainties must always be discerned, especially in quantum physics. No *metaphysical* uncertainties exist in physical nature. Only out-of-context, *epistemological* uncertainties exist. Thus, Bohm's wave-function theory nicely eliminates the mystical aspects of quantum mechanics introduced by the 1926 Copenhagen Interpretation.

Those field or mode exchanges occur, for example among the gravity-fusion, matter-mode reactions of a star pushing photon quanta into the energy-field ether to radiate pressure waves, ranging from radio waves to gamma waves, toward matter-field receptors located at the end of ALL point lines of existence—such as a lens of a telescope in another galaxy. That lens withdraws a straight-line equivalent

of quantum particles or photons to relieve that point line of energy disturbance or pressure disequilibrium from the originating matter mode.

Similarly, a hydro, fossil-fuel, or fusion power plant on Earth creates and puts *human-controlled* quantum packets into, for example, a television transmitter. That transmitter, in turn, puts its signal of quanta into the unmovable energy-field ether. Such an action creates radiating lines of energy disturbances that are equilibrated by absorption of quanta into the matter field of, for example, a television receiver. The same energy/matter mode equilibrations can be traced from that television set to the retina of a human eye, then to a conscious brain, and finally to volitional physical actions.

Discrete quanta or particles move at high velocities approaching the speed of light only

HUMAN CONSCIOUSNESS IS THE PURPOSEFUL, UNMOVED MOVER OF EXISTENCE.

in: 1. certain radioactive decays or natural symmetry breakings and, in 2. conscious-controlled symmetry breaking and particle acceleration. The natural transmission of light, electro-magnetism, or quantum energy across space is not a result of any significant particle or quanta movement. But rather such linear or curved transmissions are simply energy-wave pressures or disequilibriums propagating near or at the speed of light through an endless, unmovable energy field or ether. Thus, discrete energy quantum and matter quantum do not themselves travel across space. Instead, each adds pressure to the stationary lines of force radiating throughout space. Those energy disequilibriums are relieved or absorbed by matter-mode receptors at velocities approaching the speed of light.

Consider *locally* creating and relieving energy pressures by emitters and receptors in a stationary energy-field ether. Now, consider today's notion that almost every particle ever created or released physically races across light years of space. That notion seems to violate Feynman's "least-action" (or least-time) principle. Indeed, such an action-inefficient notion of endlessly traveling quanta seems as quaint as the notion of a geocentric universe in which all inertial matter, planets, and stars daily race around planet Earth. Both matter and energy consist of force fields that interact locally, not across space. Light, for example, does not literally propagate across time and space. But, rather, light locally manifests a change of field state or mode throughout existence. Thus, from the frame of reference relative to field effects of light or to *field effects of human consciousness*, actions simultaneously manifest themselves throughout existence.

Then what really is the "speed of light", C? First, consider atomic fission or fusion in which all of a given mass is converted to energy as $E=MC^2$. Now, by contrast, the "speed of light", C, is the velocity at which all of a given energy is converted to mass as $M=E/C^2$. Yet, light itself is the opposite—it has no mass. So where is the connection of light to the velocity, C? There is NONE!! the "speed of light", C, is NOT THE SPEED OF LIGHT AT ALL, BUT

RATHER "C" IS THE VELOCITY RELATIONSHIPS OF MASS AND ENERGY FIELDS. LIGHT, GRAVITY, Mr. Newton, AND HUMAN CONSCIOUSNESS ARE INTERRELATED. THEY HAVE NO PATHS OR SPEED LIMITS.

CONSCIOUS CONTROL OF "EXISTENCE"

The above example of an energy-releasing star can be "deterministically" calculated from the "immutable" cause-and-effect of existence *WITHOUT* conscious influences. But, the above example of an energy-releasing television transmitter is the volitional dynamics of existence being integrated, controlled, and forever altered by freewill human consciousness. Thus, all existence is ultimately controlled, predictable, and evolved through volitional human consciousness.

Unknown to the busily self-serving Establishment, the above nature of existence and its dynamics of matter and energy are today being methodically verified—experimentally and mathematically. That verification process will lead to the verification of a corollary fact of

nature: human consciousness *IS* the eternal integrator and controller of existence—Montauk experiments or not! That, in turn, will lead to the verification of the fourth and controlling mode of existence—the mode of human consciousness, which controls the relationships of matter, energy, and time throughout existence. HUMAN CONSCIOUSNESS IS THE PURPOSEFUL, UNMOVED MOVER OF EXISTENCE. And, finally, that verification will reveal the eternally evolving Civilization of the Universe throughout existence. All conscious efforts will then harmonize through objective justice. Thus will flow limitless benefits to every conscious being here on Earth. And then, this anti-civilization will VANISH.

THE FUTURE PERCEPTIONS

I need to leave this document as we are out of "time". Good grief, will we never be able to give up these limiting perceptions?

At any rate, as we move along you will understand, as some readers and listeners here today already KNOW, that the scientific and mathematical verifications of the preceding facts will VANISH Earth's dangerous, irrational civilization. That VANISHING of Earth's anti-civilization will occur as the secure, rational Civilization of the Universe comes into being worldwide. You will foretell and COMMAND THE FUTURE by controlling the force field that reaches into the future—into the Civilization of the Universe.

What does this mean? It means that the appearance of the Civilization of the Universe will ultimately deliver limitless power and prosperity TO EACH AND EVERY CONSCIOUS BEING.

Let us leave this now to the digesting systems of the listeners—especially Mr. Newton et al. who are guests today in a most unsuspected form. Thank you for attending. You CAN GIVE that MANKIND CAN LIVE AND FLOURISH—OR, YOU CAN STAND BY AND CONTRIBUTE TO THE DOWNFALL OR THE VANISHING OF A SPECIES. THE HUMAN OF GOD SHALL NOT PERISH—BUT WILL HAVE EVERLASTING LIFE!

Timely Warnings

(Continued from Front Page)

lance and there is NO NEED to get hurt while doing your citizenship tasks.

I am not going to take time to reprint the article in point as it is from July 4, 1993 and as regards the tightening down on you citizens I think it more important that we share a bit from a book which we will have to check out more thoroughly. I am told the document sent to my attention is a chapter from a book and by the headings, I believe it to be: *YOUR HOUSE IS UNDER ARREST*. And GLORY BE!—it is written BY AN ATTORNEY in Mill Valley, California. The notation says it comes from The Institute for The Preservation of Wealth, Inc. Burnsville, MN. Since the book is \$75 a copy I will not take liberties with the material.

What I am offered here is a portion from Chapter 18 so my assumption is that you get a lot of bang for your buck in this volume. I'm sorry that I have no further information to offer you regarding the volume itself.

You are going to find that you have a lot of repeating in concept from our journal on "privacy" but specifically this deals with how to act and how to protect yourself when they come to your DOOR and how to LEGALLY effort at protecting yourself, family and property. My suggestion, however, is that you give them whatever they want IF they tell you they will shoot you dead! If the callers are not in the shoot-you-on-the-spot mode, protect yourself by using the rules and laws.

ALWAYS STAY ALERT—THE GOING THING IS TO PLANT BITS OF ILLEGAL SUBSTANCES, CASH WITH DRUG ODORS AND WHAT-NOT AROUND YOUR HOUSE—AND THEN "FIND" IT.

First, however, I need to share some other urgent and important information.

From the Militia of Montana (MOM), yesterday, came an INTEL REPORT dated July 20, 1994.

I have told you that massive and critical plans were afoot and the Jupiter "thing" was just a tragic deception and distraction. Why do you think they reported such close proximity of the Jupiter probe? You had better wake up, sleepy-heads.

Now, before I share MOM's material with you I have something to say in behalf of Dharma—to them.

You will see that embarrassment over running such controversial material is up front—but they chose to get it out on the hot-lines ANYWAY. Things "far-fetched" sounding, like bombing Jupiter, Electro-magnetic space attack against you-the-Earth, photon belts and ignited atmospheres—are stuff nightmares are made of. We chose years ago to run the scientific reports regarding the Photon Belt. We advised you to get VERY dark glasses and that at least a #15 welder's goggle or shield was necessary for full protection. We have been ridiculed off the globe! We have been accused of having interest or owning a "goggles" factory and being outright "psychic" frauds. Col. Gritz has had the most fun poking at

this—BUT YOU KNOW WHAT—YOU ARE IN THE PHOTON BELT FRINGE. Why do you think all the blatherings about cancer and high (above ultraviolet) rays from the unshielded sun and thus and so? Why do you think that in some areas animals AND people are going blind from being outside? THIS IS THE PHOTON BELT. Next, they have developed a weapon which BLINDS—IT BLINDS WHOLE ARMIES—permanently! A beam can be shot at a landing plane, for instance, and confuse and BLIND the pilot—causing crashes—and it is done almost every day NOW.

The reason, however, for the suggestion that you always carry goggles with you—for at least self—is that if you are out driving and the IGNITION OF YOUR ATMOSPHERE HAPPENS—you will have someone who can lead others to safety as THEY COVER THEIR EYES WITH MANY LAYERS OF PAPER, CLOTH OR WHATEVER THEY CAN GRAB INSTANTLY—IMMEDIATELY. Not only will the sheer brightness of such intensity be destructive to sight—BUT, THE FREQUENCY OF THE HIGH FREQUENCY INVISIBLE RAYS ARE TOTALLY DESTRUCTIVE IN FOCUSED BLASTS. LAUGH IF YOU LIKE, READERS, BUT I PROMISE YOU NOW—HE WHO LAUGHS LAST WILL LAUGH LONGEST!! Now, dear ones, I suggest that our "hot-line" bear a reminder about this possibility—through the next few weeks. When the electromagnetic wave hits your planet from the detonations on Jupiter—the POSSIBLE happening could well be detonation of some of the satellite-based NEUTRON WARHEADS—WHICH CAN RELEASE ENOUGH PRANA (SCALAR, ORGONE, ETC.) TO IGNITE THE RADIATION BELT AROUND YOUR ATMOSPHERE—AND IF THAT HAPPENS IT IS GOING TO TAKE ABOUT THREE DAYS TO BURN OUT—AND ALONG WITH IT, MANY EYES WILL BE BLINDED! Is it so difficult for you to accept the need to prepare? What have you lost if NOTHING happens? So you have a pair of goggles—maybe someday you can take up welding—to put all the pieces back together after THE BIG ONE!

The warning from "MOM" is worthy of attention. This information comes from PEOPLE WHO ARE IN THE LOOP OF KNOWING WHAT IS PLANNED—NOT PSYCHICS or FORTUNETELLERS, PROPHETS OR NERDS—YOUR SCIENTISTS ARE SCARED SPITLESS, GOOD BUDDIES.

[QUOTING:]

FOR WHAT IT'S WORTH

From: Militia of Montana (MOM), c/o P.O. Box 1486, NOXON, MT 59853. 406-847-2246 v/fax.

1. REPORTED EVENING OF JUNE 19, 1994: A SECRET PROGRAM STARTED BEFORE 1991 TO SEND A ROCKET TO JUPITER TO ARRIVE SIMULTANEOUSLY WHEN THE FRAGMENTS OF THE COMET WOULD STRIKE. THIS

ROCKET WAS CARRYING 49 1/2 LBS OF PLUTONIUM AND EQUIPPED WITH 750 KILO TON NUCLEAR WAR HEAD (A COMPARISON: HIROSHIMA WAS HIT WITH A 50 KILO TON BOMB). THIS IS AN EXPERIMENT BY SCIENTISTS WHO WORK FOR THOSE WHO RUN THE SHADOW GOVT. THIS EXPERIMENT WAS DONE IN ORDER TO SEE IF THEY COULD IGNITE THE PLANET IN SUCH A WAY THAT IT WOULD SEND OUT AN ELECTRO-MAGNETIC PULSE (EMP). THIS PROJECT IS CALLED "APPLE JACK 95" [H: So guess what they have in store for you next year!!] THIS PROJECT IS PART OF A PROGRAM TO DEPOPULATE THE EARTH (GLOBAL 2000 PROGRAM COMMISSIONED BY FORMER PRESIDENT JIMMY CARTER—2 BILLION TO BE LEFT ON EARTH). THIS EMP IS TO HIT THE EARTH ON JULY 26 IN THE EASTERN HEMISPHERE. HOWEVER, IT IS NOT CLEAR AT THIS TIME WHETHER THIS DATE IS MEANT FOR THE WESTERN HEMISPHERE OR THE EASTERN HEMISPHERE. IF IT IS MEANT FOR THE EASTERN, THIS WOULD MEAN THE WESTERN HEMISPHERE COULD FEEL ITS EFFECTS ON JULY 25. ALSO, IT WAS STATED THAT THE STRENGTH OF THIS EMP COULD CAUSE THE DEATH OF OVER 2 BILLION PEOPLE. HOWEVER, IF IT DOES NOT HIT THE WESTERN HEMISPHERE DIRECTLY THE EFFECTS WOULD NOT BE AS GREAT; WE WERE ALSO TOLD THAT THE WESTERN HEMISPHERE WILL FEEL NOTHING IF IT HITS THE EASTERN HEMISPHERE. HOWEVER, THIS IS AN EXPERIMENT AND NOBODY REALLY KNOWS WHAT MAY HAPPEN. IT COULD HAVE NO EFFECT, OR, 2 BILLION DEAD. NOBODY KNOWS.

MOM HAS BEEN TOLD THAT THE WAY TO DETECT IF YOUR AREA WILL BE AFFECTED BY THE EMP IS TO HAVE YOUR RADIO TUNED INTO AN A.M. RADIO STATION. IF THE SIGNAL ON YOUR RADIO IS SUDDENLY LOST AND YOU HEAR STATIC, YOU WILL HAVE 38 MINUTES TO PREPARE. SO WHAT CAN WE DO TO PROTECT OURSELVES? WE WERE TOLD THAT IF YOU HAVE A BASEMENT, ROOT CELLAR OR BOMB SHELTER (SOMETHING UNDER GROUND) TO GO INTO IT AND STAY NEXT TO THE EASTERN-MOST SIDE OF YOUR SHELTER. THE EMP WILL LAST ONLY APPROXIMATELY ONE MINUTE. THIS REPORT WAS TOLD BY A XXXXX WHO WAS XXXXX IN THE XXXXX.

ALSO, WE ARE STILL WORKING ON VERIFICATION THAT RUSSIA HAS BEEN PRACTICING WAR DRILLS WITH THE CIVILIAN POPULATION IN THEIR COUNTRY. THEY ARE PRACTICING GOING INTO BOMB SHELTERS, ETC. CONNECTION WITH THE ABOVE??

MOM's THOUGHTS ON THE ABOVE

MOM HAS RECEIVED NUMEROUS REPORTS COMPARABLE TO THE ABOVE IN THE PAST. SO WHY ARE WE PUTTING THIS ONE ON THE NETWORK?

1. THIS REPORT CAME FROM A XXXXX WHO XXXXX ON THE XXXXX.

2. A PATRIOT INVESTIGATOR WHO HAS BEEN VERY RELIABLE ON INTEL IN THE PAST HAS ALSO BEEN WORKING ON THIS AND BELIEVES THIS REPORT TO BE CREDIBLE ENOUGH TO BE TAKEN SERIOUSLY.

3. WE REPORTED IN THE MAY ISSUE OF [MOM Newsletter] "TAKING AIM" THAT THERE ARE FOUR RUSSIAN TYPHOON CLASS SUBS OUT OF MOBILE BAY. EACH OF THESE SUBS

CAN CARRY 22 INTERCONTINENTAL MISSILES WHICH HAVE MIRV CAPABILITY WHICH MEANS THAT EACH OF THESE 22 MISSILES CAN CARRY 5-10 MULTIPLE WAR HEADS ON THEM. AFTER FURTHER INVESTIGATION, WHEN EXPLODED AT THE PROPER DISTANCE THESE WAR HEADS CAN CAUSE AN EMP THAT WILL SHUT DOWN ALL ELECTRONICS THAT ARE NOT SHIELDED PROPERLY. WE ARE NOT SURE WHAT KIND OF DAMAGE THIS CAN CAUSE TO LIFE.

4. ALSO, WE KNOW THAT THERE IS ANOTHER ELECTRO-MAGNETIC GRID THAT HAS BEEN ESTABLISHED BY THE WORLD CONTROLLERS FOR THE PURPOSE OF WEATHER AND/OR MIND CONTROL BY SENDING EMPs OVER THIS GRID WHEREVER THEY WISH. (EXAMPLE: WOODPECKER SIGNAL NEAR EUGENE, OREGON DURING THE EARLY 1980s AND INVESTIGATED BY BOB BECK IN 1984—SEE THOMAS BEARDEN'S *SOVIET WEATHER WARS OVER AMERICA*.)

SUMMARY: WE, AT MOM, BELIEVE IF THIS TAKES PLACE IT WILL BE USED AS A COVER FOR OTHER PURPOSES. WHAT ARE WE GOING TO DO? WE ARE GOING TO MAKE SURE WE HAVE A RADIO TUNED TO AN AM STATION ON THE DAYS OF JULY 25 AND 26 AND IF STATIC COMES ACROSS WE WILL NOT PUT OUT A REPORT ON IT UNTIL AFTER WE ARE SURE THAT IT IS SAFE TO COME ABOVE GROUND ONCE AGAIN.

ONE MORE THING. WE HAVE BEEN TOLD THAT BY PUTTING OUT REPORTS OF THIS NATURE WE WILL LOSE OUR CREDIBILITY AND LOOK LIKE FRUITCAKES IF THE SITUATION DOES NOT COME TO PASS. WE WOULD LIKE TO KNOW IF YOU WISH TO RECEIVE THESE TYPES OF REPORTS AND NOT HAVE THE SITUATION OCCUR OR WOULD YOU RATHER WE NOT PUT OUT THE REPORT AND HAVE IT OCCUR. PLEASE LET US KNOW, THANK YOU.

[END OF QUOTING]

I don't think I need to comment—except as to the major results of a longer duration, of such electromagnetic wave blasts. The human immune system is all but devastated by such bombardment—much as with overdoing x-rays and/or any invisible high frequency tampering. This will, at best, leave massive numbers of people as open for disaster as is happening in Zaire today with the refugees from Rwanda. Just one assault of great magnitude can literally wipe out all the already compromised bodies within a short period of time, i.e., AIDS victims will be very hard hit allowing for overtaking by opportunistic disease. In other words, you will have been hit by very high levels of radiation any way you define it.

WHICH HEMISPHERE?

I don't suggest much attention to hemispheres—GET PREPARED WHEREVER YOU ARE. YOU WON'T KNOW UNTIL TOO LATE IF IT HITS YOU. I do ask that you go back to one of the early journals and read about the Elite plans for luxury living quarters in AUSTRALIA so that "they" could conveniently sacrifice the entire NORTHERN HEMISPHERE if necessary to gain their PLAN. I told you then that the facilities were to be finished and airstrips removed (only entry into the areas would be by helicopter and hover craft) by January, 1993. THAT HAPPENED! The facilities are finished and here is an interesting letter which arrived

on this desk TODAY:

[QUOTING:]

July 11, 1994

...For your information, in May 1994, while flying from Sydney to Hong Kong via Cathay Pacific, we crossed over the northeast portion of Australia. I had noticed that on tourist maps this particular area was marked as restricted as it was "aboriginal land". About 4 or 5 hours out of Sydney, I looked down on the mountains and noticed that the tops of a large number of mountains/hills had what appeared to be large square objects on top which I can best describe as "windows". Oddly enough there were no roadways leading to the mountain tops. I counted at least 20. I cannot claim to understand what they were. Might it be that they are part of an underground complex?

Understanding and appreciating the tremendous responsibilities you have, I humbly ask if you would consider answering a few questions put forth by my friends and myself.

[END OF QUOTING]

I will try to take up the questions asked at the next meeting [see p.12 for *The Word to order meeting tapes of 7/24/94*] to save time. However, I will deal with this topic above, now.

Those are "light" and "power" portals, pods, whatever you wish to call them. There is an ability to hide every trace of those panels when appropriate. There is a LOT THAT DOESN'T "SHOW" which is actually very much in the open because—even with artificial [underground] air control—it is desirable to use natural atmosphere when possible and as long as possible. These facilities are very definitely NOT for the aboriginal people and actually is not a "government" complex as much as a privately Elite owned place for luxurious "survival". Remember my warnings? If you don't have a ticket to Australia for your services—you aren't in the "IN" crowd and you had better get worried. There are lots of OTHER places around—but THAT ONE is THE Cadillac of the bunch. The "no roadways" and "no landing strips" are for exactly THAT: "no" entry except by invitation and by hover-craft! All traces were removed over two years ago and the final pull-out of all workers was over a year-and-a-half ago. There are other places in Australia and New Zealand as well.

I would point out that these installations are more set up for the Elite of the Committee of 300 and attachments than for, say, the Committee of 17. You can know this because of the connection with such as the Tavistock Institute and, also, the fact that these are BRITISH-controlled lands. The sender of this information, by the way, is one of our "close" Canadian friends.

As we talk of "preparations", readers, it is almost now an afterthought because you are INTO the happenings which in fact are the "ending" intentions of the PLANNERS 2000. So, the messages are now clear and the *WRITING'S ON THE WALL*:

[QUOTING:]

WHAT TO DO WHEN
YOU SEE THEM COMING FOR
YOUR LAND

Information: *YOUR HOUSE IS UNDER AR-*

REST, Brenda Grantland, Institute for The Preservation of Wealth, Inc., Burnsville, MN. [H: If anyone has this book, please send us the full ordering information so that we might better tell you how to work with these people who produce this volume. If the remainder of the book is as good as Chapter 18—it is worth every cent invested. I doubt that Burnsville, MN is so large as to not allow for tracking these people down if you really try. I don't have the time this morning so will leave it to the sleuths.]

Don't wait until the police break down your door with a battering ram to prepare for a police raid. As soon as you have reason to believe the police are likely to target your home, unimproved land, or business property, you need to get everything ship-shape.

The advice in this chapter assumes you already know that police have you, your relatives, friends, business associates, enemies, customers, tenants, etc., under investigation. This could easily happen to anyone, even Mother Teresa. For example:

* Your mortal enemy or business competitor could get arrested and, to "work off his charges", become an informant for the police. He could lie and tell the police that you are doing something illegal. The police could use that to get a search warrant for your home or business, or both.

* You could invest money in an enterprise that gets seized under RICO.

* Your child, your tenant, or houseguest could get arrested for having drugs on your property.

* An informant, a total stranger with a long string of felony convictions, could finger you for 25% of your assets. He could have gone to great lengths to find out factual details about you, in order to have bogus "corroborating evidence" for his tips.

* You could get fingered by the computer at FinCEN, because of large or complex financial transactions you made as you moved your investments between banks, bought and sold stocks, refinanced and purchased real estate or businesses. They look for "suspicious" transactions, using an artificial intelligence (an advanced type of computer program that allows the computer to "reason") program which looks for patterns that match their complex profiles of money laundering activity. We don't know how accurate these techniques are. And once they target you, you're presumed guilty under the money-laundering forfeiture laws.

IF YOU THINK THEY
ARE AFTER YOU,
CONSULT A LAWYER, NOW!

If you think "they" are after YOU, you need a criminal lawyer. Don't wait until they come to your door with a search warrant. Find a good [H: GOOD LUCK!] criminal lawyer. Look in the newspapers to see which lawyers have gotten people off, or appear to be experienced. Ask around. Talk to people they have represented.

Do all that, but act quickly. You need a lawyer fast.

If you think "they" are after your child, business associate, customer or tenant, you might still want to line up a criminal lawyer for yourself—just in case you are called before the grand jury to testify against them. (see below).

TIME TO CLEAN HOUSE

Once you know the forfeiture squads are after your property, you have to change your living habits. You can't live as if you have any right to privacy anywhere anymore. It's time to clean house, at both your home and business.

* Don't make it easy for them to find anything that incriminates you. If you know your kids or any employees are using drugs, insist that they stop it. If you aren't 100% confident that they have quit, make them move out. Do a thorough job of checking your premises to make sure they take every vestige of drugs and drug paraphernalia out of your house. To the police, paraphernalia includes potting soil and growing equipment, grow lights, postage or dietary scales, razor blades, aluminum foil and baggies, as well as pipes, tiny spoons, alligator clips, etc. That doesn't mean you can't have a postage scale in your office, or aluminum foil and baggies in your kitchen, but if anything looks out of place or suspicious to you, you can bet it will to the police.

* Don't keep a diary. Look at what happened to Senator Packwood—no right to privacy will protect it from government intrusion. You never know what detail it might corroborate of some informant's tall tale about you. If you already have a diary and don't want to throw it away, don't keep it at your home or office—especially after you have been targeted.

* Ditto with photo albums. Loan them to grandma or your sister—she'll enjoy them.

* Ditto with calendars and address books. If they tell your life story, get them out of your sight. Keep only the information you need to get by day-to-day, and keep the rest of your calendars and address books somewhere apart from you, but safe. You might want to get one of the loose-leaf organizers to use in the meantime. That way pages of your calendar that are history can be removed and stored away from you or recycled.

* Ditto with utility bills, general correspondence, and anything with other people's name on it. They don't need to know who you associate with. It gives them more leads in their fishing expedition.

* Ditto with your tax returns and any financial papers.

* Back up your computer files. Get a good computer encryption program, and protect all your files.

* Make a complete back-up set of the documents you will need to keep your business running (billing records, client files, banking records) as well as the documents you need to prove how you acquired each of your valuable assets, any documents explaining unusual surges in income (e.g., insurance claim payoffs, lawsuit settlement money, gifts and inheritances, lottery winnings, unusually large tax refunds, etc.). Keep this set of documents in a very safe place away from you or your property. This is very important, because, when the police come with a search warrant, they will confiscate all of your papers. They will not leave you with a set of them to use to keep your business afloat, and they will not freely give them back to you to use to defend your case. In the Durling case, where police seized the businesses, cars and bank accounts of three generations of a family, they also seized all their records. This left the Durlings without the documents to disprove the government's claim, in the forfeiture case,

that money was laundered through the businesses. When the Durlings demanded their documents back so they could defend themselves, **the government made the Durlings pay for photocopying—\$5000 worth of photocopying!**

* Watch what you put in your trash. Police are now trained to go through the trash of suspects under investigation. Your deepest darkest secrets may be revealed through your trash. **Nothing illegal, obscene, embarrassing, or private should ever go into your trash.**

* All private documents you choose to dispose of should be shredded or burned in your fireplace or barbecue grill. Be sure to thoroughly crush the ashes, because forensic experts have been known to decipher writing on burned paper, using infrared photography.

* Watch who you phone, and from where, and don't charge calls on your long distance calling card that you wouldn't make from home.

* Assume that your phone is tapped. Don't discuss things that could embarrass you later. Never talk in code over the phone, even in jest. Don't even use inside jokes that could be interpreted as talking in code. The government will put on an expert witness (a cop) who will testify as to what your "talking in code" really means. Even if you make up the code, they will come up with something damaging—and maybe even more damaging than what you really intended.

* Instead of looking over your shoulder, assume they could be following you and act accordingly.

* Obey the law. Don't even speed or park illegally. Make sure your car is in compliance with all safety regulations so they won't have reason to stop you for a "traffic infraction".

* Don't get into arguments with your enemies, any government agents, or anyone else who might develop a motive to set you up for a cut of the proceeds.

* Don't call anyone you think might have set you up.

* If the police approach you, be courteous, but insist on your rights. **Don't consent to let them search and don't answer any questions**, other than giving your name and identification. Tell them to speak to your lawyer if they have any questions.

* Don't send anything by UPS that you wouldn't want the police to see. United Parcel Service has played a pivotal role in a number of forfeiture cases in the last few years. **[H: Remember WACO!]**

In 1992, Maryland police officers dressed in UPS uniforms and driving a UPS truck rang the doorbell of Pamela Davis's house in Westminster, Maryland. When her teenage daughter opened the door, they delivered a UPS package, containing 1.5 ounces of marijuana, which neither Pam nor her daughter were expecting. When the police came back with a search warrant a little while later, Pam's son was up on the roof, eating the marijuana. In addition to the UPS package of marijuana, the police found a baggie containing less than an ounce of marijuana in Pam's bedside table. Pam was at work the whole time.

The police arrested Pam's son and daughter. Nineteen days later they arrested Pam. They seized all her computer equipment, which she used to run her imported clothing business. They threatened to seize Pam's 54-acre farm and 20-room, 18th century farmhouse, saying it would make a nice Fraternal Order of

Police retreat.

Pam immediately hired a lawyer and fought for return of her property. The court ordered the computers returned. This ruling sent the county forfeiture squad reeling. They thought the forfeiture was a done deal.

The case against her daughter was dismissed after her judge found the search warrant illegal. Her son pleaded guilty and received probation before judgment, which ended when Pam paid a \$1,000 fine—5 minutes later.

Unfortunately, Pam's case was assigned to the same judge who gave the police the warrant based on the cops' hand-delivered probable cause. Because Pam was representing herself (having spent all the money she could raise defending her children and getting back her computers), Pam missed a 20 day deadline for filing motions to suppress evidence. Despite her pleas, Pam's judge—the one who signed the search warrant—would not let her litigate the legality of the warrant.

Pam went to trial, before the same judge who signed the search warrant, and was convicted. She was sentenced to six years in jail, all but 2 suspended, followed by 5 years supervised probation including drug treatment. She was released on bond pending appeal after serving eight weeks in prison, the first 11 days in solitary confinement.

Pam Davis's farm was never seized, probably due to the voluminous anti-forfeiture publicity, and the amount of public outrage about the case. But Pam's judge made up for it by refusing to grant Pam's motion for bond pending appeal. Pam did 51 days in prison before getting out on bond pending appeal. It looks like she may not have to serve any more time, but the damage has already been done. Pam's health has been wrecked by this ordeal, and her children have lost all their faith in this country. Her finances have been destroyed, and now she has to sell the farm anyway.

Pam Davis is not the only victim set up by UPS informants. "Presumed Guilty", the powerful forfeiture exposé by Andrew Schneider and Mary Pat Flaherty published in August 1991 in the *Pittsburgh Press*, showed UPS was involved in setting up forfeiture seizures as early as 1990. Part IV of the series, "The Informants", Aug. 14, 1991, says:

"The absence of regulations spawns 'privateers and junior G-men', says Steven Sherick, a defense attorney in Tucson, Ariz., who recently recovered \$9,000 for John P. Gray of Rutland, Vt., after a UPS employee found it in a package and called police.

"Gray, says Sherick, is 'an eccentric older guy who doesn't use anything but cash.' In March 1990, Gray mailed a friend hand-money for a piece of Arizona retirement property Gray had scouted during an earlier trip West, say court records. The court ordered the money returned because the state couldn't prove the cash was gained illegally.

"It could be that UPS employees are collecting informant rewards from the government, just like airline ticket counter employees are for reporting travellers who purchase tickets with cash."

While you're at it, expect not to have privacy in anything you send by UPS's competitors. I asked a Federal Express desk clerk what procedures they have to go through before opening a package they consider "suspi-

cious." She said they would call in the DEA dogs, hide the package amid a lot of other packages and let them sniff it out. If the dogs pick out the package, she said, then they would probably get a court order to open it. She thought it was company policy to get a court order before opening the package, but she wasn't absolutely certain.

Since recent chemical analysis studies, including a study conducted by the DEA, show that the U.S. currency supply is highly contaminated with cocaine residue by contact with other bills as well as contact with the belts in the sorting mechanism from the Federal Reserve System, **drug-sniffing dogs will alert to most currency.** If there is cash in a package and they do the experiment the Federal Express employee discussed, the dogs will probably alert, and the government will find and seize the cash. The unreliability of dog-sniffs to support seizure was harshly criticized in at least one federal case, based on the scientific tests showing the contamination of the money supply²⁴². However, most courts continue to place reliance on the dog-sniff as an indication of involvement of the money in drug trafficking.

²⁴² *Jones v. U.S. Drug Enforcement Administration*, 819 F. Supp. 698, 719-21 (M.D. Tenn. 1993). This is the famous case of Willie Jones, the shrubbery [dealer] who was stopped in the Nashville airport, and his \$9,600 seized, simply because he fit a drug-courier profile, and the dogs alerted to the cash. His story has been featured on CBS *60 Minutes*, and he was a witness at the first Government Operations Committee hearing before Congress on September 30, 1992.

So, before you send any cash or sensitive documents through *any* courier service, you might want to check their policies about opening packages—but do it anonymously.

WHAT TO DO IF POLICE SHOW UP WITH A WARRANT

If the police show up at your door with a warrant, there's nothing you can do but let them in. Ask to see the warrant and carefully read it over, but stay as cool, calm and collected as possible. Sometimes they refuse to show you the warrant, even when they have one. Sometimes they show you an unsigned warrant (there might also be a signed warrant somewhere, or maybe not). Insist on seeing the warrant, and check it for defects—such as: whether it is signed, whether it is for the correct address and/or person, whether it is stale (there will be a date of issuance and some indication of when it expires), and whether the warrant specifies it must be served in daytime hours²⁴³. Calmly point out any deficiencies—if they let you—and stand your ground **BUT WITHIN REASON**. Remember they've got the guns. If they don't really have a warrant, or if they insist on proceeding in spite of your protestations of defects in the warrant, remember you can raise those issues later in a motion to suppress any evidence they seize. As long as you have firmly insisted that you do not consent to a warrantless search, you don't have to do anything more.

²⁴³ Daytime hours, for purposes of service of warrants, vary from jurisdiction to jurisdiction, and can be looked up in the state penal code. In California, for example, daytime warrants must be served before 10 p.m.

Do not say anything to the cops that you don't want to hear repeated in court. Under

pressure, it's hard to tell what things might be misconstrued, so, instead of talking to them at all, repeat this phrase:

"I'm not willing to answer any questions until I have consulted my lawyer."

Repeat this answer over and over each time they ask you a question.

Don't resist arrest. If their warrant was based on false information, you can move to suppress the evidence later. Resisting arrest will only endanger your life. They kill and beat people for that now—look at the Randy Weaver case in Idaho, the Waco, Texas tragedy, and Rodney King.

WHAT TO DO IF THEY SHOW UP WITHOUT A WARRANT

Whether you are at home, at someone else's home, in a public place, or in a car, and the police want to search you, your car or your premises, ask them to get a search warrant. Ask politely, but be insistent. Try to make sure witnesses hear you demand a warrant.

But they might not need a search warrant if the circumstances fit within one of the exceptions to the warrant requirement. The exceptions to the warrant requirement are:

- * consent search
- * plain view
- * search "incident" to an arrest
- * Terry stop and frisk
- * automobile exception
- * exigent circumstances
- * hot pursuit

DON'T CONSENT TO A SEARCH

If the police ask your permission to search, and you agree, then their search is legal, and anything they find can be used against you or confiscated without a warrant. This is the one excuse to search without a warrant that you can totally avoid. **NEVER CONSENT TO A SEARCH.** Calmly say:

"I am an American citizen with constitutional rights. If you want to search my car/house/boat, etc., get a warrant."

Do that even if you think you have nothing to hide. You never know what someone else might have left in your car or house. They might find your cash and seize it, saying it is "drug money", as the Volusia County Florida forfeiture squads did throughout 1992, to tourists headed to Disney World and other travellers along Interstate 95.²⁴⁴

²⁴⁴ "Tainted Cash or Easy Money? Volusia Deputies Have Seized \$8 Million from I-95 Motorists. The Trap Is For Drug Dealers, But Money Is The Object. Three of Every Four Drivers Were Never Charged," by Jeff Brazil & Steve Berry, *Orlando Sentinel*, June 14-17, 1992 (also June 19 & June 25). This series won a Pulitzer Prize in 1992. [H: By the way, "not getting charged" does NOT MEAN that you get your money back!]

If police tell you that if you don't consent to a search, they will make it harder on you, or that your refusal to

consent could be used against you in court, they are lying—don't give in. If they threaten, as they often do, that if you don't consent to a search, they will make you stay there all day while they go get a search warrant, or that they will trash your house if they have to go get a search warrant, call their bluff—make them get a warrant. **These are your constitutional rights at stake here—assert them, that's what they are there for!** You can rest assured that if they intend to trash your house, they will do so whether or not you refuse to consent to a search.

Some police go to great lengths to try to coerce people into consenting to a search. At some point, police threats and promises used to induce you to consent to a search go too far, and invalidate any consent you give. But it will be up to the judge in your trial whether the consent was coerced. Don't take chances. It's hard to prove your consent was coerced. It's better to not give it to them.

Take for example the outrageous search that Jamestown, California resident Andrew Tomaselli and his wife Nita Torres were subjected to. These are Andrew's own words:

"On June 1, 1993, at approximately 11:45 a.m., my wife, Nita, and I along with company from out of town were relaxing on our lawn, recapping the highlights of the bluegrass music festival we had just attended. Suddenly, three unmarked vehicles came racing down our driveway, nearly running over our dogs. Seven or eight men immediately jumped out with guns pointed upward and screamed at us to get our hands on top of our heads...

"I cannot describe the terrible feeling of imminent death or injury at the hands of the yet unidentified thugs. We were herded to our car and forced to place our hands on the blazingly hot hood of our vehicle. From the corner of my eye, I observed one of the gunmen enter our house with his gun raised.

"Not until the gunman returned outside and yelled out, "House secured," and our bodies were searched, did the men

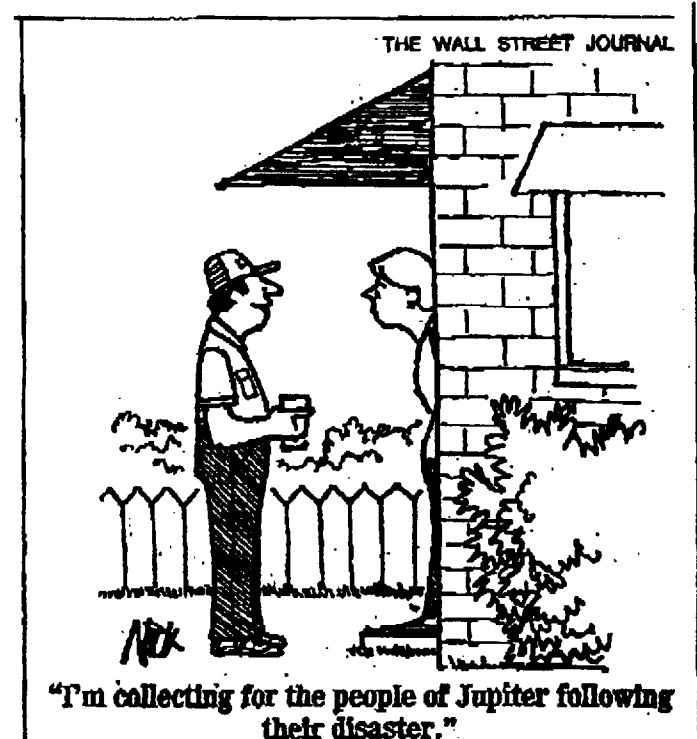

identify themselves as drug agents. We were finally told that the neighbor had observed us growing and picking marijuana.

"I breathed a slight sigh of relief upon hearing this because I wasn't growing and had never grown marijuana in my life. Yet when my thoughts collected, a shaking terror returned as I finally realized that these must be the same men involved in a shooting incident about 2 to 3 weeks prior in the nearby town of Columbia, in which persons playing with a cap gun were shot [by ACTNET officers].

"At that point the agents, representing the Amador, Calaveras and Tuolumne County Narcotics Enforcement Team (ACTNET), identified themselves as such and told us no one may leave or enter the property. They then told us we had two choices. An agent, identified only as John, said:

'The first choice is that you cooperate fully with us, consent to a search of the property and we'll be out of here in a half hour. Or you can refuse and remain on the lawn for 4 or 5 hours waiting until the search warrant is served.'

"My wife replied, 'This is not our house; we are only the caretakers here. Can I call up the owners and ask them what we should do?' Agent John replied, 'Nobody can use the phone or enter the house.'

"I said to agent John, 'You came here to find marijuana under cultivation; feel free to look around the property for any signs of this. The neighbor saw me weeding mint from our herb garden.' I then pointed to the trash can of mint and weeds destined for the compost pile. I next said, 'After you look through our yard and see for yourselves that a serious mistake has been made, please leave the premises.' The agent said no and also stated that, 'If you do not consent to a search now, we can make it harder on you.'

"Fearing that the owner's house would be turned upside down, I signed a consent to search form, under duress and coercion."

Did Andrew do the right thing to break down and let them search? NO. He later told the local newspaper:

"Out of sheer terror I decided to let them search.... I'm not up on my legal rights."²⁴⁵

²⁴⁵ See also "Drug Raid Ordeal Infuriates Couple: Neighbor Mistook Mint For Marijuana," by Ron DeLacy, *Modesto Bee*, June 5, 1993.

Andrew learned the hard way that **if you don't know your rights, you're likely to lose them.**

KNOW YOUR RIGHTS!

If the police don't have a warrant, and they don't have your consent, they can only invade your "reasonable expectation of privacy" in your land, your car, and your personal effects if the circumstances fit one of the following narrow exceptions:

PLAIN VIEW SEARCHES

If the police are in a place where they have

a legal right to be—such as, on a public street, or inside your house with your consent—they can seize anything in "plain view". "Plain view" means anything they can see without having to go into another room, open drawers, cabinets, closet doors, look under the bed, etc.

The only other requirements are that the discovery be inadvertent, and that the items seized be immediately recognizable as evidence.²⁴⁶ Police have interpreted this doctrine as also giving them license to seize anything they say may be subject to forfeiture.

²⁴⁶ *Texas v. Brown*, 460 U.S. 730(1983).
Washington v. Chrisman, 455 U.S.1(1982).
Coolidge v. New Hampshire, 403 U.S.443(1971).

Many "plain view" searches and seizures can be prevented by not consenting to the entry of the police onto the premises. So, if police officers come to your house collecting for the Police Benevolent Fund—especially if they express interest in buying one of your dog's puppies²⁴⁷—don't invite them into the house. You might end up giving them a larger donation than you intended.

²⁴⁷ The puppy adoption ploy is very common now with potential forfeiture targets who have dogs. Don Scott was one of two cases I have seen where the police come to the target's home on one or more occasions prior to a raid, on the pretext of wanting to adopt or buy a puppy. In both cases, the officers used the opportunity to make friends with the dogs. This ploy obviously made it easy to invade the property secretly, without the owners' dogs alerting them, and allowed the police to gain entry to the house so they could know its layout in advance of the raid.

SEARCH INCIDENT TO ARREST

If the police have probable cause to arrest someone, they have the power to search him or her, and seize evidence or forfeitable items on them,²⁴⁸ in their car if they are driving²⁴⁹ or in the area "within the arrestee's immediate control".²⁵⁰

²⁴⁸ *Gustafson v. Florida*, 414 U.S.260(1973).
United States v. Robinson, 414 U.S.218(1973).

²⁴⁹ *New York v. Belton*, 453 U.S.454(1981).

²⁵⁰ *Chimel v. California*, 395 U.S.752(1969).

AUTOMOBILE EXCEPTION

Because an automobile is mobile and can easily be removed from the scene, the Supreme Court has allowed the police to stop an automobile (or other conveyances such as an airplane or boat) and search it, without a warrant, if they have probable cause to believe it contains contraband,²⁵¹ or if they have probable cause to arrest the driver.²⁵²

²⁵¹ *Carroll v. United States*, 267U.S.132(1925).

²⁵² *New York v. Belton*, 453U.S.454(1981).

EXIGENT CIRCUMSTANCE SEARCH

"Exigent circumstances" means the evidence is about to be destroyed or taken away, and therefore there is not enough time to obtain a warrant. It also arises when police officers are confronted by emergency situations, such as a fire or a report of a wounded person inside premises, and enter to stop the emergency.

For example, firemen who enter premises and put out a fire can report to the police

anything they see while inside the premises. That would not allow the police to enter without a warrant, but if the police accompany the firemen inside in order to help rescue someone, then they are legitimately on the premises and can seize things found in plain view. [H: **Shades of the tales of O.J. Simpson??**]

A number of state courts and lower federal courts have approved searches under this doctrine, although it has never been approved by the U.S. Supreme Court.

HOT PURSUIT EXCEPTION

The police, in hot pursuit of a fleeing felon, can chase the felon into your living room. If they find contraband in plain view in your living room, or catch you in the act of doing something illegal, or see other evidence in plain view, they can seize it without a warrant.²⁵³ The police must have continuous knowledge of the felon's whereabouts. They can't see him run into your house, then come back an hour later, without a warrant, and bust inside.

²⁵³ *Warden v. Haydon*, 387 U.S.294(1987).

SUPPOSE YOU GET INVITED TO TESTIFY BEFORE THE GRAND JURY

Usually you have no choice but to appear—because you are subpoenaed. But that doesn't mean you have to answer all their questions. You can "take the Fifth" and refuse to answer any questions "that might tend to incriminate you". But, unless you have a criminal defense lawyer go over your testimony in advance, you will have great difficulty deciding what statements might "tend to incriminate you".

The first thing you should always do when subpoenaed before the grand jury is **consult a criminal lawyer**. [H: **I thought most lawyers were "criminal". No, that is just a jab, too much fun to pass up!**] Make sure you get a **good, experienced criminal lawyer**. [H: **Oh, one with good references in criminal activities? As a matter of fact, all joshing aside—I think you at CLC, etc., should get this lady on your REFERENCE LIST—TO HELP YOU LOCATE SUCH LAWYERS—WHEN YOU NEED THEM IS TOO LATE MOST OF THE TIME!**] The best corporate attorney in the world won't substitute. Putting together a team of the best legal minds of six other fields won't substitute for **one dedicated, experienced criminal lawyer**.

You should consult a criminal lawyer even if you think you have nothing to hide. Even if they are not targeting you, you could end up saying something damaging that makes them target you next. For example:

I had a client whose boyfriend was charged with killing a child he was babysitting. My client was not present when the murder occurred, but she had spoken to him that day over the phone. He had called her several times, and had acted odd in the phone conversations. She decided to go over to his house and see what was wrong. She got there just as the ambulance took the dead child away.

She was subpoenaed to testify before the grand jury investigating the murder. She hired me to advise her because she was scared. The stress of reliving the ordeal had put her into such a state that she was having to go through counselling, and was still having nightmares about it.

It was a good thing that she consulted me, because there was some damaging evidence that she didn't know about that could have caused her to be suspected of child abuse too.

The autopsy of the child showed old scars, and evidence of abuse over a long period of time. In the grand jury they questioned her about her relationship with the defendant, how often she had taken care of the child, and other questions aimed at discovering whether she might have been abusing the child too. She was totally cleared after the grand jury investigation (and rightfully so), but you never know what would have happened had she not been prepared for the grand jury ordeal.

You never know. The physical manifestations of shock, after being accused of such a heinous crime, could **alone** be misinterpreted by the grand jury as evidence of guilt.

**TAKING THE "FIFTH" MEANS
EVIDENCE THEY WON'T
HAVE—AT LEAST NOT
FROM YOUR MOUTH**

By learning in advance exactly where to draw the line, and "take the Fifth" instead of answering questions, you can avoid giving them statements from your own mouth that could be used against you.

You are probably wondering—*Wouldn't that make the grand jury suspect you more, the fact that you "took the Fifth" instead of answering the question?*

Maybe so, but suspicion is not evidence.

If they already have probable cause to believe you have committed a crime, they will indict you anyway. Anything you say will just help them build their case against you. And if they don't have probable cause to indict you, don't give them extra ammunition to get an indictment—don't say anything.

It is often said, amongst both criminal defense lawyers and prosecutors, that a grand jury will "indict a ham sandwich". That refers to how easy it is for prosecutors to get a grand jury to indict someone.

The grand jury meets in secret, with only the prosecutor and witnesses the prosecutor subpoenas allowed to attend the proceedings. One witness appears at a time, in a very coercive atmosphere, in which most witnesses receive at least subliminal threats that they may be implicated as well if they do not "cooperate" with the grand jury investigation.

Defense lawyers and the public are never allowed inside the grand jury room. The press is totally excluded. A court reporter takes down a transcription, but it is immediately sealed, and only the prosecutor gets to see it—ever—with only one exception.

If there is a criminal trial in a case the grand jury votes to indict, the criminal defendant gets to see a transcript of the prior testimony of any government witnesses who testified in the grand jury on that case, but the transcript isn't required to be revealed to the criminal defendant until **after** the witness testifies at the criminal trial.²⁵⁴ And that's the only exception to grand jury secrecy. No one other than the criminal defendant who is targeted gets to see the grand jury testimony at all.

²⁵⁴ The Jencks Act, 18 U.S.C. Sub.3500.

The other reason you hire a lawyer if you are subpoenaed before the grand jury is that the lawyer can sometimes get the government to agree to give you "use immunity". "Immunity" means you would be "immune" from being prosecuted for anything you say to the grand jury. "Use" immunity means they can't use it against you at trial. In other words, they could still prosecute you if they have evidence wholly separate from your statements to the

grand jury. But at trial, they would not be allowed to use your statements before the grand jury, or any evidence your statements lead them to.

ASSERT YOUR RIGHTS

Hopefully this chapter has taught you enough about your legal rights that you will know when to assert them. If you think your property is likely to be the target of a search warrant, don't keep anything illegal, obscene, embarrassing, or private there. And don't throw it in your trash without shredding or burning it.

If the police show up with a warrant, cooperate but keep your mouth shut. If they show up without a warrant, don't consent to a search.

And if you are subpoenaed to testify before the grand jury, get a criminal lawyer immediately.

[END OF QUOTING]

I won't comment on how much of this seems so far-out that you couldn't ever "be in such a situation". All of it is now within, not the possibility, but the **PROBABILITY** of happening to you as you move on into the close-down portion of your non-Constitutional way of life—moving into a POLICE STATE.

I will remind you, however, ATTORNEYS DO NOT COME CHEAPLY—AND NEVER "FREELY"—SO IT IS BETTER TO ACT ALWAYS WITHIN THE RULES AND REGULATIONS AND TAKE ACTION WHERE YOU ARE ALSO SECURE. YOU HAVE ENTERED A MOST SAD TIME, READERS—MOST SAD INDEED! Always act within wisdom—and without foolishness and we can make it through. Charge forth with guns and force—and you will be stopped! Salu.

NEW VIDEOTAPE: THIS IS TREASON

Readers will remember, from the 6/28/94 issue of *CONTACT*, the scope and seriousness of President Clinton's recently signed Executive Order 12919. Well, Al Carter of The American Institute For The Republic has just completed a videotape which clearly explains the implications of this diabolical Executive Order, combined with the Top Secret document *Silent Weapons For Quiet Wars*, which *CONTACT* has also published. For those of you searching for a teaching vehicle that can be used to vividly convey to friends, family, or elected officials the severity of our national slide into slavery, this videotape would be an excellent choice.

When ordering the videotape, also included is the riveting document *Silent Weapons For Quiet Wars*, plus a copy of the actual Executive Order 12919.

To order this tape, send \$29.95 (shipping is included in the price) to:

The American Institute For The Republic
60 E. 100 S., Suite 201
Provo, UT 84606
(801) 377-0570

New Gaia Products

SPELT

Spelt is the most ancient and very best grain. *Spelta* is a grain of its own unique being. It is the best fiber resource, and has large amounts of B-17 (anti-carcinoma). It is the grain GOD gave to the planet as "manna" when humans were placed upon it.

Spelt was brought from the Middle East more than 9,000 years ago; it is a well tested product. It has since spread over the European Continent. Very recently, *Spelt* has enjoyed renewed popularity in Europe as a result of translations of mystical writings of the 12th century healer, St. Hildegard of Bingen, who praised *Spelt* as the grain best tolerated by the body. The *Old Testament* mentions *Spelt* in *Exodus* 9:31, 32 and *Ezekiel* 4:9.

Today it is used in the West in much the same way as wheat; one main distinction is that the people with allergies to wheat frequently do not react to *Spelt*. Although *Spelt* contains gluten, those with gluten sensitivity, even celiacs, can usually tolerate it. In addition, *Spelt* is appreciated as much for its hearty nut-like flavor as for its healing qualities.

The grain berry grows an exceptionally thick husk that protects it from pollutants and insects. It is stored with its husk intact, so it remains fresher. Thus, unlike other grains, it is not normally treated with pesticides or other chemicals. The strong, protective husk may also be a metaphorical signature of this grain's capacity to strengthen immunity. *Spelt* contains special carbohydrates (Mucopolysaccharides) which are an important factor in blood clotting and stimulating the body's immune system.

Spelt is richly endowed with nutrients. In general, it is higher in protein, fat and fiber than most varieties of wheat. An important feature is its highly water-soluble fiber, which dissolves easily and allows for efficient nutrient assimilation by the body. *Spelt* also contains essential amino acids, which combine with the protein in *Spelt* constitute a source for human plasma. To use *Spelt* in baked goods, cereals and other dishes calling for wheat or other grains, substitute it one for one. You will likely always have to add gluten (from wheat) to give satisfactory yeast products.

At a major clinic in Konstanz, Germany, *Spelt* has been used as an adjunct in the treatment of

many disorders, especially chronic digestive problems of all kinds, chronic infections (herpes, AIDS), nerve and bone disorders (Parkinson's disease, Alzheimer's disease, arthritis), cancer and antibiotic side effects.

GAIANDRIANA

Gaiandriana is a non-alcoholic health tonic which provides basic "foods" to help cells, weakened by the stresses of modern life, to return to a state of health.

The better our cells function, the greater is the stamina returned to our internal defense systems, and the better we can counter the constant onslaught of biological and viral invaders. The end result is a feeling of well-being by, of course, being well.

The Gaiandriana (commonly referred to as "chondriana" in the Biological literature) are capable of intelligent, organized attack against cellular invaders like viruses. Think of it as a "pac-man" operation of sorts. However, beyond

that, the Gaiandriana are capable of stimulating cellular structural repairs due to damage caused by, for instance, free radicals and cumulative levels of so-called "background" radiation in our modern environment. Healthy DNA and RNA within the nuclei of our cells then lead to properly formed and concentrated enzymes, upon which healthy cellular function depends.

Gaiandriana liquid is made entirely from wholesome natural ingredients.

AQUAGAIA

Complementary to the Gaiandriana product, AquaGaia is also a non-alcoholic health tonic which

provides basic "foods" to help cells, weakened by the stresses of modern life, to return to a state of healthy function.

AquaGaia contains *mitochondria*. These are the major biochemical energy "processors" within cellular metabolism. First, enzymes begin the breakdown process of organic nutrients (like fats, carbohydrates and proteins) to intermediate substances such as amino and pyruvic acids. Then, in the next "bucket brigade" step, these various acid molecules are processed within the mitochondria to release chemical energy

recognized as adenosine triphosphate (ATP).

About 95% of the energy needed to "run the machinery" that keeps each cell going and healthy is produced in the mitochondria. Unfortunately, the mitochondria are particularly damaged by free radicals and cumulative levels of so-called "background" radiation in our modern environment. These compromised mitochondria, like half-dead batteries, then lead to impaired cellular functioning and health. Thus is the importance of AquaGaia, with its assimilatable supply of healthy mitochondria — like "fresh batteries" for the body's cells.

The better our cells function, the greater is the stamina returned to our internal defense systems, and the better we can counter the constant onslaught of biological and viral invaders.

2/11/93 #2 HATONN

GAIANDRIANA & AQUAGAIA

To help in understanding the workings of these organic "pac-men" you must realize that there is a protein covering "cap" on viruses. The protein cap is centered on a charged zinc atom and is the part of the virus that recognizes and binds to DNA—in turn allowing the virus to reproduce.

AquaGaia, in conjunction with the Gaiandriana, knock out the zinc atom (a simple "charge" change), which renders the protein ineffective. This is a breakdown of "parts" of the Gaiandriana male-female DNA structure which releases many working variants but freed the Gaiandriettes or "killers" to take out that zinc atom and pass right into the affected cell. Without the "cap", the virus cannot reproduce and infect more cells—further, the damaged virus feeds the Gaiandriana unified cells and the circulating mitochondria.

Healthy cells are not affected because they lack the zinc-centered protein cap on the virus.

These "Gaia" compounds have an effect on cancer cells because they stop an enzyme on the cancer cells from producing a "messenger" molecule that blocks a second enzyme from attacking the cancer cell's DNA. The compounds (Gaia) have been seen to actually take out leukemia, breast, brain and colon cancer cells. We have no claim to anything other than stating that people utilizing these simple and natural substances do show improved well-being and do report feeling generally and, often remarkably, improved as to state of health, thought processes and stamina.

The obvious conclusion is that there might well be good reports of better health and faster recovery, following infection by other viruses, than those mentioned above. All viruses known react in generally the same manner.

It is known that many diseases are due to retroviral DNA and these are the most affected viruses by the Gaia-chondrianas (living crystal forms). We, again, make no medical claims—we are simply reporting in an effort to explain WHAT takes place within the cellular structures of living organisms.

NOW AVAILABLE

GAIA TRIM

**ALL NATURAL
FAT-BURNING
SYSTEM**

**THE NATURAL FAT-BURNING
SYSTEM TO HELP YOU LOOK
GOOD AND
FEEL GREAT.
LET NATURE HELP YOU REDUCE.**

**30 DAY SUPPLY: \$35.00
PLUS SHIPPING AND HANDLING.**

(See Next-To-Last Page for ordering information,
see Next Page for more information.)

NOTE

If any product you receive has an unpleasant odor — it is from the finishing culture process. Leave the bottle open to air and it will quickly dissipate. Then, depending on taste and preference—**refrigerate after opening** and reclosing.

IMPORTANT: Do not mix the two, Gaiandriana and AquaGaia, together for storage as the AquaGaia (mitochondria) are aggressive and begin to "eat" the Gaiandriana for fuel. Once ingested, they go about their appointed tasks, but in bottle prisons they are not particularly compatible once the available fuel supply is exhausted. Juices are excellent to take with the AquaGaia because the mitochondria must have the fuel derived from same, the most effective juice being from the tropical "Guava" fruit. Any juice is fine, however, and is most pleasant to intake. Diabetics should utilize whatever juices are available on their food plan to keep within the safe guidelines for calories and other requirements.

The most innocuous and easy intake available is simply a few drops under the tongue, both products taken at the same time or at different times of the day. Once the "initial" program is completed, and the maintenance level of intake is being followed, certainly the drops under the tongue are the least annoying to any daily regimen.

GaiaLyte

GaiaLyte is brought forth from Kargasok Tea. This IS the basic component of MO-GU tea as we have used the tea by that name. The GaiaLyte is a fully integrated electrolytic liquid. The "drink" is a "concentrate" (3 to 1 minimum—as much to one as you like maximum). It contains EVERYTHING supplemental to Gaiandriana—INCLUDING A GROWING-PROGRAMMING BASE OF GAIANDRIANA AND BASIC DRIANAS. It also contains enough Carbragaia to equal a full schedule of what is being used in Mexico—(shark-fin cartilage). If you are using MO-GU—keep on—it can only enhance your full-rounded intake—but it WILL NOT be the same. However, the "new" drink will supply all you need without it. This is NOT A MEDICAL PROGRAM OF ANY KIND. We are not physicians as in Medical Doctor; we are not anything—except hopefully, sharers of information.

The GaiaLyte has a full spectrum of vitamins, minerals, Ginkgo, Echinacea, Chlorella, Oxygenators, Aloe Vera—everything necessary to "program" the cells in the tea membrane AND the Gaiandriana included. This does not replace the Gaiandriana used otherwise. This is a PERFECT medium to enhance the ability of the Gaiandriana you already take to enhance itself—reinforcement fuel, if you will.

You can dilute the concentrate with water AND/or anything you like. May we recommend apple juice and/or Cranberry. The apple juice is to flush out the gallbladder and the cranberry juice flushes out the bladder (urine). You may use as much as you like of either OR both and we would hope you would do so on a continuing basis because of the value of these two products and their focus of use.

We believe you will find it a very tasty beverage but we ask that no matter how "good", just keep to the "program" amounts or you may find yourself a bit "woozy" immediately after intake. This is due more to the Aloe Vera present than

the tea itself—but as you know, even the MO-GU tea can make you quite light-headed. There is no alcohol in the beverage although you may very well think so as the body rushes to uptake the fuel supply. This is not a medical-chemical concoction so you could take the entire bottle without damage or hazard—but you might well not feel so great for a bit afterward and it is totally UNNECESSARY for any expected positive response.

This is not like taking an antibiotic with flu or sore-throat. This is a well-body systemic enhancement. It sometimes, as with other persons' elixir—takes weeks or months to feel any difference. ONCE balanced, however, you will note that at onset of infection, cold, etc., if you take around six ounces of Gaiandriana and double up on the GaiaLyte—you will probably note positive response in about an hour. Remember—you are activating the enhanced immune system and it takes a while to accomplish this task.

ALOE JUICE

**(Whole Leaf, Cold Pressed
Aloe Vera Concentrate)**

Aloe Vera has a long and impressive history that spans hundreds of centuries, countries and cultures, and appears in countless "folk remedies" as a plant revered for its healing qualities.

Aloe Juice is a whole-leaf concentrate prepared from the freshly harvested leaves of the *Barbadensis Miller Aloe Vera* plant. **Aloe Juice** guarantees a minimum of 10,000 mg. of mucopolysaccharides per liter.

The nutrients reported in Aloe Vera include mucopolysaccharides and polysaccharides (glucomannans), glycoproteins, glucose, mannose, galactose, xylose, arabinose, tannins, steroids, organic acids, antibiotic principles, glucuronic acids, enzymes (oxidase, catalase and amylase), trace sugars, calcium oxalate, a protein containing 18 amino acids, "wound healing" hormones, biogenic stimulators, saponins, vitamins B1, B2, niacin, B6, choline, folic acid, chloride, sulfate, iron, calcium, copper, sodium, potassium, silicon, manganese, plus many other metabolism-assisting components.

CHLORELLA

Chlorella is a nutritionally balanced whole food and contributes to the health and growth of human cells like no single vitamin or mineral possibly can.

Chlorella is extremely high in protein (60%) and contains more than 20 vitamins and minerals, 19 of the 22 essential and non-essential amino acids, enzymes and chlorella growth factor. It is one of the richest sources of RNA and DNA known and has twenty times as much chlorophyll as alfalfa, 10 times more than other edible algae including spirulina, and 10 times more than barley grass.

Chlorella is a natural vitality enhancer. The vitamins found in chlorella cells include: vitamin C, provitamin A, B-carotene, chlorophyll-A, chlorophyll-B, thiamine (B1), riboflavin (B2), pyridoxine (B6), niacin (B3), pantothenic acid, folic acid, vitamin B-12, biotin, choline, vitamin K, PABA, lipoic acid, inositol and para-aminobenzoic acid. The minerals include: phosphorus, potassium, iodine, magnesium, sulphur, iron, calcium, manganese, copper, zinc and cobalt.

The amino acids include: lysine, histidine, arginine, aspartic acid, threonine, serine,

glutamic acid, proline, glycine, alanine, cystine, valine, methionine, isoleucine, leucine, tyrosine, phenylalanine, ornithine, tryptophan.

The suggested daily consumption is 3 grams per day.

GaiaTrim

**Excerpt from 3/1/94
CONTACT, p. 10**

2/23/94 #1 HATONN

I have been nagged and badgered to put together something that would help to remove and keep off excess body fat. You people are so focused on the purely physical aspect of experience as to concern me. However, there IS need among the population for some help in controlling the negative problems of "lipoid and horizontally challenged" people. Of course there is an array of natural herbal assistants for the problem. There are also the very practical programs available for self-hypnotic training for the body. Our people will, my request was by mid-March, have a full "program" in herbal form to interact with the fat molecules which will cause them to "liquefy" and then with abundant fluid intake, wash away the surplus cellular material. The reason this is so valuable is that you are leaving your necessary muscle tissue untouched which produces the end results of a lean, healthy body. You will have to check with the "Gaia" people for we don't stick our noses into the business of the product offerings. Do "I" present the formulas and "create" the products? Not in all instances—but yes, I do. Dharma is stuck with the nasty job of physically combining the substances and doing the "gardening". However, she then has nothing further to do with the management or presentation. I can promise you, for instance, that she thought she could make bread until she reaches Heaven's gate. I watched her "trying" to put a loaf together from a batch of spelt which had lost its instruction label—and GONE were the steps and amounts.

We remove these tid-bits from her memory for the most part for she has enough other topics with which to deal and we want NO connections with the other entities and companies handling product-FOR OBVIOUS REASONS!

Now as to the self-help training program—it IS hers. She developed it in 1986 for a totally different purpose but it has a weight reduction program built in (or NO program at all is acceptable—you can still fully utilize the tapes). The tapes have been abundantly used in the management of bulimia and anorexia as well. America West offered the sets for a while until she withdrew them. There are probably a hundred or so sets left. The contact addresses, of course, are now different but the personal interaction remains open and valid. They are recognized as positive help programs and even the Master Hypnotist Teacher and head of the Council of Hypnotist Examiners have featured and "sold" the program to students.

It DOES mean however that you can't fail to attend your own personal care for self—the tapes or the capsules DO NO GOOD IN THE CLOSET—RESULTS ALWAYS DEPEND ON THE DESIRE FOR CHANGE—THEY ONLY HELP YOU ACCOMPLISH THAT CHANGE.

**To order
call...**

1-800-639-4242

Hydrogen Peroxide Use For Water Purification

To purify water (of viruses as well as bacteria and other critters) for drinking purposes, use 10 drops of 35% Food Grade Hydrogen Peroxide per gallon of water and agitate container enough to mix well.

Locating the 35% Food Grade Hydrogen Peroxide can be a problem as the Elite effort to close down everything that promotes health, from products to therapies. Food Grade Hydrogen Peroxide is necessary as the drugstore (3%) variety contains additives and stabilizers not good for ingestion.

New Gaia Product Update

- **Gaia-Trim NOW AVAILABLE**
- **GaiaSorb Starch Neutra-Bond (2oz.) Now Available**
- **GaiaSorb Travel Pack NOW AVAILABLE**
- **CarbraGaia** [see 3/1/94 CONTACT, pgs. 10 & 37, for description]

Since it will be several weeks before the first of these products become available to order, please keep your eye on this box for availability updates!

New Gaia Products 1994 Order Form

** SHIPPING & HANDLING RATES:

FOR: CA, WA, OR, AZ, MT, UT, ID, CO, NM, WY, NV		FOR THE REST OF CONTINENTAL USA	
\$ 0-100	\$6.00	\$ 0-100	\$8.00
\$ 101-200	\$7.00	\$ 101-200	\$9.00
\$ 201-300	\$8.00	\$ 201-300	\$10.00
\$ 301-400	\$9.00	\$ 301-400	\$11.00
\$ 401-500	\$10.00	\$ 401-500	\$12.00
\$ 501-600	\$11.00	\$ 501-600	\$13.00

ALASKA & HAWAII PLEASE CALL FOR SHIPPING RATES

NOTE:

- ** For UPS 2nd day to Rural Alaska, please call for rates.
- ** For Priority Mail to any locations, please call for rates.
- ** All Foreign orders, please contact our office in writing for specific rates as rates vary greatly.
- ** When ordering cases of product call for shipping rates.

FOR ALL BREAD MACHINES, BREAD MIXES, FLOUR ORDERS, PROGRAM STARTING PACKAGES AND MAINTENANCE PACKAGES, CALL FOR SHIPPING COSTS.

Order by Mail

New Gaia Products,
P.O. Box 27710,
Las Vegas, NV 89126

(Please Print)

Order by Phone

1 (800) NEW-GAIA (639-4242)

Name _____ Date _____

Street Address _____

City/Town _____ State/Prov. _____ Zip Code _____

Daytime Phone No. _____

Credit Card No. (Visa, Master Card or Discover) _____ Expiration Date _____

Signature For Credit Card Orders _____

Item	PRICE PER UNIT	Qty.	Amount
• GAIANDRIANA 8 oz. LIQUID Subscribers \$12.50 Non-subscribers \$16.00			
• GAIANDRIANA 16 oz. LIQUID Subscribers \$25.00 Non-subscribers \$32.00			
• GAIANDRIANA 32 oz. LIQUID Subscribers \$50.00 Non-subscribers \$64.00			
• AQUAGAIA (Mitochondria) 8 oz. LIQUID Subscribers \$12.50 Non-subscribers \$16.00			
• AQUAGAIA (Mitochondria) 16 oz. LIQUID Subscribers \$25.00 Non-subscribers \$32.00			
• AQUAGAIA (Mitochondria) 32 oz. LIQUID Subscribers \$50.00 Non-subscribers \$64.00			
GAIALYTE (2 liters) Subscribers \$15.00 Non-subscribers \$20.00			
GAATRIM - 30 Day Supply	\$35.00		
A-C-E Anti-Oxidant Formula (180 TABLETS)	\$24.95		
•• ALOE JUICE (1 LITER) (WHOLE LEAF ALOE VERA CONCENTRATE) (10X STRENGTH)	\$18.00		
•• ALOE JUICE (16 oz.) (WHOLE LEAF ALOE VERA CONCENTRATE) (15X STRENGTH)	\$16.00		
CHLORELLA (1/2 lb.) (500 TABLETS/500mg. EA.)	\$32.00		
ECHINACEA GOLD PLUS (90 TABLETS)	\$24.50		
GINKGO BILOBA (24% Extract)	\$24.95		
•• SUPER OXY (1 qt.) (CHERRY-BERRY) (CRANBERRY-APPLE)	\$18.00		
SUPER OXY (1 gal.) (CHERRY) (CRANBERRY)	\$60.00		
TOTAL THIS COLUMN			

- ADDITIONAL DISCOUNTS AVAILABLE FOR CONTACT SUBSCRIBERS ONLY.
- ASK ABOUT OUR QUANTITY DISCOUNTS.
- ASK ABOUT OUR OTHER ALOE PRODUCTS.

PLEASE USE THE SHIPPING RATE CHART WHEN CALCULATING SHIPPING FOR ALL NON-BREAD or PROGRAM STARTING PACKAGES and MAINTENANCE PACKAGES.

-- New Gaia Products.

Item	PRICE PER UNIT	Qty.	Amount
HITACHI (HB101) BREAD MACHINE (FACTORY BLEMISHED/REFURBISHED)	\$149.00		
GAIA SPELT BREAD MIX (Whole Wheat & Spelt)	\$ 3.50		
GAIA SPELT BREAD MIX (Pure Spelt)	\$ 3.50		
WHOLE SPELT KERNELS 4 lbs. @ \$1.25/lb. 10 lbs. @ \$1/25/lb.	\$ 5.00 \$ 12.50		
WHOLE GRAIN SPELT FLOUR 2 lbs. @ \$1.25/lb. 4 lbs. @ \$1.25/lb. 8 lbs. @ \$1.25/lb.	\$ 2.50 \$ 5.00 \$ 10.00		
* PROGRAM STARTING PACKAGE 1 Bottle Gaiaandria (1 qt.) 1 Bottle AquaGala (1 qt.) 2 Bottles GaiaLyte (2 liters each) 4 Pkgs. Spelt Bread Mix 5 Audio-cassettes	\$180.00 \$150.00 for CONTACT subscribers only.		
* MAINTENANCE PACKAGE 1 Bottle Gaiaandria (1 qt.) 2 Bottles GaiaLyte (2 liters each) 4 Pkgs. Spelt Bread Mix	\$115.00 \$ 90.00 for CONTACT subscribers only.		
GAIASORB NEUTRA-BOND (2 oz.) NICOTINE__CAFFEINE__ALCOHOL__ SUCROSE__STARCH__ GAIASORB NEUTRA-BOND TRAVEL PACK	\$ 6.00ea. \$ 15.00		

Please make all checks and money orders payable to:
New Gaia Products,
P.O. Box 27710,
Las Vegas, NV
89126

TOTAL THIS COLUMN		
TOTAL FROM OTHER COLUMN		
SHIPPING & HANDLING		
SUB TOTAL		
SALES TAX Nevada residents only, add 7%		
TOTAL ENCLOSED		

PHOENIX JOURNALS LIST

THESE WORKS ARE A SERIES CALLED THE **PHOENIX JOURNALS** AND HAVE BEEN WRITTEN TO ASSIST MAN TO BECOME AWARE OF LONG-STANDING DECEPTIONS AND OTHER MATTERS CRITICAL TO HIS SURVIVAL AS A SPECIES. **SINGLE JOURNALS** ARE \$6.00, ANY **4 JOURNALS** ARE \$5.50 EACH, **10 OR MORE JOURNALS** ARE \$5.00 EACH (Shipping extra - see right).

**** These marked JOURNALS are out of stock until further notice.**

- | | | |
|--|--|---|
| <p>**1. SIPAPU ODYSSEY</p> <p>2. AND THEY CALLED HIS NAME IMMANUEL, I AM SANANDA</p> <p>3. SPACE-GATE, THE VEIL REMOVED</p> <p>4. SPIRAL TO ECONOMIC DISASTER</p> <p>**5. FROM HERE TO ARMAGEDDON</p> <p>**6. SURVIVAL IS ONLY TEN FEET FROM HELL</p> <p>7. THE RAINBOW MASTERS</p> <p>**9. SATAN'S DRUMMERS</p> <p>**10. PRIVACY IN A FISHBOWL</p> <p>**11. CRY OF THE PHOENIX</p> <p>**12. CRUCIFIXION OF THE PHOENIX</p> <p>**13. SKELETONS IN THE CLOSET</p> <p>**14. RRPP - RAPE, RAVAGE, PILLAGE AND PLUNDER OF THE PHOENIX</p> <p>15. RAPE OF THE CONSTITUTION</p> <p>**16. YOU CAN SLAY THE DRAGON</p> <p>**17. THE NAKED PHOENIX</p> <p>**18. BLOOD AND ASHES</p> | <p>19. FIRESTORM IN BABYLON</p> <p>**20. THE MOSSAD CONNECTION</p> <p>**21. CREATION, THE SACRED UNIVERSE</p> <p>**23. BURNT OFFERINGS</p> <p>**24. SHROUDS OF THE SEVENTH SEAL</p> <p>**25. THE BITTER COMMUNION</p> <p>**26. COUNTERFEIT BLESSINGS THE ANTI-CHRIST BY ANY NAME: KHAZARS</p> <p>27. PHOENIX OPERATOR-OWNER MANUAL</p> <p>**28. OPERATION SHANSTORM</p> <p>**29. END OF THE MASQUERADE</p> <p>38. THE DARK CHARADE</p> <p>39. THE TRILLION DOLLAR LIE THE HOLOCAUST VOL. I</p> <p>40. THE TRILLION DOLLAR LIE THE HOLOCAUST VOL. II</p> <p>41. THE DESTRUCTION OF A PLANET--ZIONISM IS RACISM</p> <p>42. UNHOLY ALLIANCE</p> <p>43. TANGLED WEBS VOL. I</p> <p>44. TANGLED WEBS VOL. II</p> <p>45. TANGLED WEBS VOL. III</p> <p>46. TANGLED WEBS VOL. IV</p> <p>48. TANGLED WEBS VOL. V</p> <p>49. TANGLED WEBS VOL. VI</p> <p>50. THE DIVINE PLAN VOL. I</p> <p>51. TANGLED WEBS VOL. VII</p> <p>52. TANGLED WEBS VOL. VIII</p> <p>53. TANGLED WEBS VOL. IX</p> <p>54. THE FUNNEL'S NECK</p> <p>55. MARCHING TO ZION</p> <p>56. SEX AND THE LOTTERY</p> | <p>57. GOD, TOO, HAS A PLAN 2000, DIVINE PLAN VOL. II</p> <p>58. FROM THE FRYING PAN INTO THE PIT OF FIRE</p> <p>59. "REALITY" ALSO HAS A DRUM-BEAT!</p> <p>60. AS THE BLOSSOM OPENS</p> <p>61. PUPPY-DOG TALES</p> <p>62. CHAPARRAL SERENDIPITY</p> <p>63. THE BEST OF TIMES</p> <p>64. TO ALL MY CHILDREN</p> <p>65. THE LAST GREAT PLAGUE</p> <p>66. ULTIMATE PSYCHOPOLITICS</p> <p>67. THE BEAST AT WORK</p> <p>68. ECSTASY TO AGONY</p> <p>69. TATTERED PAGES</p> <p>70. NO THORNLESS ROSES</p> <p>71. COALESCENCE</p> <p>72. CANDLELIGHT</p> <p>73. RELATIVE CONNECTIONS VOL. I</p> <p>74. MYSTERIES OF RADIANCE UNFOLDED VOL. II</p> <p>75. TRUTH AND CONSEQUENCES VOL. III</p> <p>76. SORTING THE PIECES VOL. IV</p> <p>77. PLAYERS IN THE GAME</p> <p>78. IRON TRAP AROUND AMERICA</p> <p>79. MARCHING TO ZOG</p> <p>80. TRUTH FROM THE ZOG BOG</p> <p>81. RUSSIAN ROULETTE</p> <p>82. RETIREMENT RETREATS</p> <p>83. POLITICAL PSYCHOS</p> <p>84. CHANGING PERSPECTIVES</p> <p>85. SHOCK THERAPY</p> <p>86. MISSING THE LIFEBOAT??</p> <p>87. IN GOD'S NAME AWAKEN!</p> |
|--|--|---|

FOR INFORMATION ABOUT JOURNALS, BOOKS, ETC., MENTIONED IN THIS NEWSPAPER, PLEASE INQUIRE:

PHOENIX SOURCE DISTRIBUTORS, Inc.
Post Office Box 27353
Las Vegas, Nevada 89126
1-800-800-5565
Canadians call
1-805-822-9655
(Mastercard, VISA, Discover)

Phoenix Source Distributors SHIPPING CHARGES:

USA (except Alaska & Hawaii)
 UPS-\$3.75 1st title, \$1.00 ea add'l
 Bookrate-\$2.50 1st title, \$1.00 ea add'l
 Priority-\$3.40 1st title, \$1.00 ea add'l
ALASKA & HAWAII
 Bookrate-\$2.50 1st title, \$1.00 ea add'l
 Priority-\$3.40 1st title, \$1.00 ea add'l
 UPS 2nd day-\$9.00 1st title, \$1 ea add'l
CANADA & MEXICO
 Surface-\$3.00 1st title, \$1.50 ea add'l
 Airbook-\$4.50 1st title, \$2.00 ea add'l
FOREIGN
 Surface-\$3.00 1st title, \$1.50 ea add'l
 Airbook-\$8.00 per title estimate
 (Please allow 5-8 weeks for delivery on all book orders)

CONTACT: THE PHOENIX PROJECT Subscription Rates

CONTACT: THE PHOENIX PROJECT
 is published by
 CONTACT, Inc.
 Post Office Box 27800
 Las Vegas, Nevada 89126

Subscription orders may be placed by mail to the above address or by phone to 1-800-800-5565. Subscription rates are: \$20 for 13 issues (US); \$22 (Canada/Mexico); \$30 (Foreign); or 26 issues for \$40 (US); \$44 (Canada/Mexico); \$60 (Foreign); or 52 issues for \$75 (US); \$80 (Canada/Mexico); \$110 (Foreign). Subscribers: Expiration date appears on right side of mailing label.

Quantity Subscriptions: \$65.00 for 10 copies of 13 issues (US); \$97.50 for 25 copies of 13 issues (US); \$135. for 50 copies of 13 issues (US); \$250 for 100 copies of 13 issues (US); \$500 for 100 copies of 26 issues (US); or \$1,000 for 100 copies of 52 issues (US). UPS postpaid Continental U.S. For Alaska, HI, Canada, Mexico and Foreign, call or write for shipping charges.

Single copies of back issues of **CONTACT**, **THE PHOENIX LIBERATOR** or **PHOENIX EXPRESS** are \$1.50 each. Quantity back issue prices are as follows: 1-10 copies \$1.50 each; 11-50 copies \$15.00; 51-100 copies \$25.00. Shipping included, postpaid in the Continental U.S.A. Alaska, Hawaii, Canada & Foreign orders please call or write for quotes on additional shipping charges.

Copyright Statement

COPYRIGHT 1994 by CONTACT, Inc. Reproduction of this newspaper for private, non-profit use is expressly encouraged, as long as the content and integrity remain absolutely unchanged. For commercial purposes, reproduction is strictly forbidden unless and until permission is granted in writing by CONTACT, INC.

PLEASE NOTE:
CONTACT and Phoenix Source Distributors are NOT the same! Checks sent for JOURNALS or book orders should NOT be made out to CONTACT -- and vice versa.

"Ye shall know the TRUTH and the TRUTH shall make you mad!"

◆ ◆ ◆ ◆ ◆
SUBSCRIBE TO CONTACT CALL 1-800-800-5565

TELEPHONE HOTLINE 805-822-0202

This is a service for our dedicated readers. *Today's Watch* telephone hotline carries the latest news and comments from Commander Hatonn's most recent writings. This is our way of keeping you informed about fast-breaking news and events.

The message machine will answer after 2 rings if there are any new messages for that day, and after 4 rings if not. Thus *daily* callers can hang up after 2 rings and save toll charges if no new message has been recorded. The message update(s), if any, occur by 6 PM Pacific Time.